



# PANASIA PRODUCT CATALOGUE

泛亚卫浴产品图册



官网 / URL: <http://www.hz-panasia.com>

工厂地址 / Add.: 浙江杭州桐庐经济开发区天鹤路 1405 号  
No.1405, Tianhe Road, Tonglu Economic Development Zone, Tonglu, ZheJiang, China

诚信  
INTEGRITY

创新  
INNOVATION

合理化  
RATIONALIZATION



造世界优质厨卫产品 创泛亚百年美好事业

**PANASIA**

# INTRODUCTION OF PANASIA

## 泛亚卫浴简介

▶ 杭州泛亚卫浴股份有限公司成立于 2002 年（公司前身为创建于 1993 年的杭州泛亚金属工业有限公司），现位于浙江省杭州市桐庐经济开发区，是一家从事厨卫家居产品设计、制造和销售的高新技术企业，注册资金 9380 万元。旗下有杭州汇家厨卫用品有限公司、杭州百德嘉厨卫科技有限公司、杭州泛家电子商务有限公司、杭州泛光金属表面技术有限公司等控股子公司。公司是目前国内最大的国际高端卫浴五金产品及配件供应商之一，为全球知名卫浴品牌提供 OEM 和 ODM 服务。

Hangzhou Panasia Sanitary Ware Co., LTD (formerly Hangzhou Panasia Metal Industry Co., LTD., founded in 1993) was established in 2002, now located in Tonglu Economic Development Zone, Hangzhou City, Zhejiang Province, Hangzhou Panasia Sanitary Ware Co., LTD is a high-tech enterprise engaged in the design, manufacturing, and sales of kitchen and bathroom home products, with a registered capital of 93.8 million RMB. The company's subsidiaries include Hangzhou Hoca Kitchen and Bath Products Co., Ltd. (referred to as "Hoca") and Hangzhou BDC Kitchen & Bath Technology Co., Ltd. (referred to as "BDC"), is currently one of the largest suppliers of international high-end sanitary ware products and accessories in China, providing OEM and ODM services to globally renowned kitchen and bathroom brands.

▶ 泛亚卫浴拥有专业、完善的产品检测体系，拥有表面处理、功能检测、盐雾、镀层、软管检测等实验室，以及金相分析、金属成分分析、三维测试仪等专业设备。

Hangzhou Panasia Sanitary Ware Co., Ltd has a professional and comprehensive product testing system, including laboratories for finish testing, functional testing, salt spray, coating, hose testing, and other tests, as well as professional equipment such as metallographic analysis, metal elements analysis, and 3D measuring.



### 实验室 TESTS

表面处理 LABORATORIES FOR FINISH TESTING

功能检测 FUNCTIONAL TESTING

盐雾 SALT SPRAY

镀层 COATING

软管检测 HOSE TESTING

.....

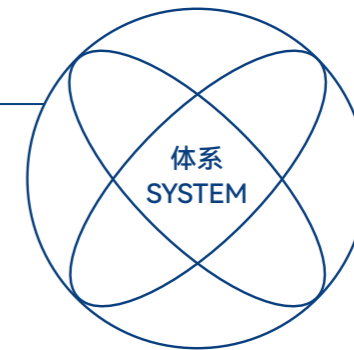

### 专业设备 PROFESSIONAL EQUIPMENT

METALLOGRAPHIC ANALYSIS 金相分析

METAL ELEMENTS ANALYSIS 金属成分分析

3D MEASURING 三维测试仪

.....





# INTELLIGENT MANUFACTURING

## 智能制造



泛亚拥有铸造、机加工、弯管、抛光、表面处理能力,具备无铅铜生产技术和高档表面处理生产工艺。凭着“诚信、创新、合理化”的企业精神,本着“造世界优质厨卫产品,创泛亚百年美好事业”的使命,为世界著名卫浴品牌商以及美国主要 RTA 厨柜销售企业供应厨卫家居产品。主要产品有排杆、龙头、弯管、软管、挂件等卫浴配件类,以及橱柜、浴室柜等厨卫家居类。

Panasia possesses a range of capabilities including casting, machining, bending, polishing, and finish process, and is equipped with No-lead copper production technology and high-quality finish production processes. Driven by the enterprise spirit of "integrity, innovation, and rationalization" and the mission of "Make world-class quality kitchen and bathroom products, create Panasia's century-long good causes", the company supplies kitchen and bathroom products to world-renowned brand merchants and major RTA kitchen cabinet sales companies in the United States. Its product portfolio includes waste drain, faucets, spouts,

泛亚投资 4.6 个亿,兴建厨卫产品智能制造基地和以泛亚省级研究院为核心的研发中心,依托现有的 ERP 系统、MES 系统、PLM 系统、WMS 仓储系统、OA 系统等信息化系统与先进制造技术不断深度融合,实现生产自动化、智能化升级,推动传统产业实现转型升级,进一步完善公司在整体厨卫领域的布局。

hoses, bathroom accessories, as well as kitchen and bathroom furniture such as cabinets and bathroom cabinets. Panasia has invested 460 million RMB to build an intelligent manufacturing base for kitchen and bathroom products and a R&D center with Panasia Provincial Research Institute as the core. By leveraging existing information systems such as ERP, MES, PLM, WMS, and OA with advanced manufacturing technology, the company has achieved production automation and intelligent upgrading, driving the transformation and upgrading of traditional industries and further enhancing its overall layout in the kitchen and bathroom field.

# FINISH CENTER

## 表面处理

泛亚表面处理中心始建于 2003 年,经过近 20 年的发展,目前已经发展成为浙江省内表面处理能力较完备,规模较大电镀及喷涂生产企业,具有行业领先的表面处理能力及电镀、PVD、喷粉和喷涂生产线,并通过国家环保审核认证,可保证生产制造的绿色安全。

Established in 2003, Panasia finish production center has become a leading plating and coating production enterprise in Zhejiang Province after nearly 20 years of development. The center boasts comprehensive finish process capabilities, including industry-leading plating, PVD, powder coating, and lacquer coating production lines. It has also obtained national environmental protection audit certification, ensuring its production is green and safe.



公司的电镀和 PVD 生产线通过了各大知名卫浴企业的认证审核,可生产近 60 种不同类型的表面产品。生产的产品可通过的测试包括:96H/ASS、24H/CASS、200H/NSS、二氧化硫试验、热震测试、水浴试验、刮擦测试、百格测试、结合中性盐雾测试、清洁剂浸泡测试、抗化学品测试、冷热循环测试、铅笔硬度测试、胶带测试、落砂测试、网格测试、锉刀测试、腐蚀泥测试、氨熏测试、温度冲击测试等。

Panasia's finish production center has been certified by major well-known brand customers and can produce nearly 60 different types of finishes. The products undergo rigorous testing, including 96H/ASS, 24H/CASS, 200H/NSS, SO<sup>2</sup> salt spray, thermal cycle, water bath, scratch, grid, cleaning agent immersion, chemical resistance, hot and cold water cycle, pencil hardness, tape, sand shot, file, corrosion mud, ammonia corrosion, temperature shock testing etc.

20年历史	国家环保认证	近60种颜色	通过多种测试
-------	--------	--------	--------



# HONORS AND QUALIFICATIONS

## 荣誉资质



HONOR  
荣誉

公司是国家高新技术企业、浙江省博士后工作站、浙江省民营科技企业、浙江制造品字标认证企业、杭州市机器换人示范企业、中国建筑卫生陶瓷协会卫浴分会副会长单位、中国五金制品协会卫浴分会副会长单位、浙江省第五届绿色低碳经济标兵企业。

The company is a national high-tech enterprise, a Zhejiang provincial postdoctoral workstation, and a private technology enterprise. It is certified as a Zhejiang brand manufacturing enterprise and a Hangzhou labor to machine replacement demonstration enterprise. Additionally, it serves as a vice president unit of the China Building Sanitary Ceramics Association Bathroom Branch and the China Hardware Products Association Bathroom Branch. The company is also recognized as the fifth Zhejiang Green Low-carbon Economy Model Enterprise.



CERTIFICATION  
认证

公司通过了 ISO9001 质量管理体系、ISO14001 环境管理体系、GB/T45001 职业健康安全管理体系认证，软管系列产品通过了 NSF61-9 认证。自 2002 年以来实施 ERP 系统管理，是杭州市工业企业信息化应用试点企业。

It has achieved ISO9001, ISO14001, and GB/T45001 certifications for quality management, environmental management, and occupational health and safety management systems respectively. The hose series products have passed NSF61-9 certification. Since 2002, the company has implemented ERP system management and is a pilot enterprise for industrial information application in Hangzhou.



PATENT  
专利

公司拥有多项发明专利和实用新型专利，通过了 GB/T29490-2013 知识产权管理体系认证，是国家知识产权优势示范企业。公司拥有以浙江省企业研究院为核心的一支由百余位工程技术人员和管理专家组成的团队负责技术研发、质量管控等工作。

The company holds multiple invention patents and utility model patents, and has passed the GB/T29490-2013 intellectual property management system certification. It is a national demonstration enterprise of intellectual property advantages. The company has a team of over 100 engineering and technical personnel and management experts responsible for technical research and development, quality control, and other work. The Zhejiang provincial enterprise research institute serves as the core of this team.

- ▶ 高新技术企业  
National High-tech enterprise
- ▶ 浙江制造认证（品字标）  
Zhejiang made ( Defined quality )
- ▶ 国家知识产权优势企业  
National intellectual property advantage enterprise
- ▶ 省级企业研究院  
Provincial enterprise research institute
- ▶ 五金制品协会卫浴分会副会长单位  
Vice president unit of the China Hardware Products Association Bathroom Branch
- ▶ 博士后科研工作站  
Postdoctoral research workstation
- ▶ 绿色低碳经济标兵企业  
Green Low-carbon Economy Model Enterprise
- ▶ ISO 质量管理体系  
ISO quality management system
- ▶ ISO 环境管理体系  
ISO environmental management system
- ▶ ISO 能源体系证书  
ISO energy management system certification
- ▶ OHSAS 职业健康体系  
OHSAS occupational health and safety management system
- ▶ GB/T 知识产权体系  
GB/T intellectual property management system
- ▶ NSF/UPC/CSA 产品认证  
NSF/UPC/CSA product certification
- .....





### 龙头类 / FAUCET

01 - Garden系列 Garden series	09
02 - Thin系列 Thin series	10
03 - Ocean系列 Ocean series	11
04 - Square系列 Square series	12
05 - Pastoral系列 Pastoral series	13
06 - 面盆龙头 Basin faucet	14
07 - 厨房龙头 Kitchen faucet	16
08 - 大淋浴 Shower	18
09 - 入墙淋浴龙头 Shower tap into wall	20
10 - 淋浴杆 Shower rod	22
11 - 美式龙头 American style faucet	23



### 浴室挂件 / BATHROOM PENDANT

01 - Knurl系列挂件 Knurl series pendant	27
02 - Laurel系列挂件 Laurel series pendant	28
03 - Mercer系列挂件 Mercer series pendant	29
04 - Stainless系列挂件 Stainless series pendant	30
05 - Simple系列挂件 Simple series pendant	32
06 - Elegant系列挂件 Elegant series pendant	33
07 - Rome系列挂件 Rome series pendant	34
08 - Glacier系列挂件 Glacier series pendant	35
09 - Plain系列挂件 Plain series pendant	36





### 排杆 / FAUCET POP-UP

01 - 提拉式去水	Pull-up type POP-UP	38
02 - 弹跳式去水	Bounce POP-UP	40
03 - 翻板式去水	Flap type POP-UP	43
04 - 常开式去水	Normally open POP-UP	44
05 - 拉线式去水	Guyed POP-UP	45
06 - 智能控制去水	Intelligent control POP-UP	46
07 - 欧式去水	European style POP-UP	47
08 - 菜盆去水	Vegetable pots POP-UP	48
09 - 浴缸去水	Bathtub Pop-up	49
10 - 下水管&存水器	Sewer & Water Trap	51



### 地漏 / FLOOR DRAIN

01 - 干区地漏	Dry area floor drain	54
02 - 洗衣机地漏	Washing machine floor drain	55
03 - 隐形瓷砖地漏	Invisible tile floor drain	56
04 - 淋浴地漏	Shower floor drain	57
05 - 矩形长条地漏	Rectangular strip floor drain	58



### 软管 / HOSE

---

01 - 不锈钢双扣管系列 Double fastening shower hose	60
02 - PVC花洒淋浴管 PVC shower hose	62
03 - 抽拉管系列 Pulling tube series	64
04 - 不锈钢连接软管 Stainless steel connecting hose	65
05 - 不锈钢防爆连接软管 Stainless steel explosion-proof connecting hose	66
06 - 抗菌龙头管 Antiseptic faucet tube	67
07 - 不锈钢波纹管 Stainless steel bellows	68
08 - 燃气波纹管 Gas corrugated pipe	69
09 - 弹簧管 Bourdon tube	70



### 水嘴角阀 / NOZZLE & VALVE

---

01 - 水嘴角阀 Nozzle & Valve	72
--------------------------	----



### 安全扶手 / BATHROOM HANDRAIL

---

01 - 安全扶手 Bathroom handrail	77
-----------------------------	----



# FAUCET

龙头类



龙头类 / 浴室挂件 / 排杆 / 地漏 / 软管 / 水嘴角阀 / 安全扶手

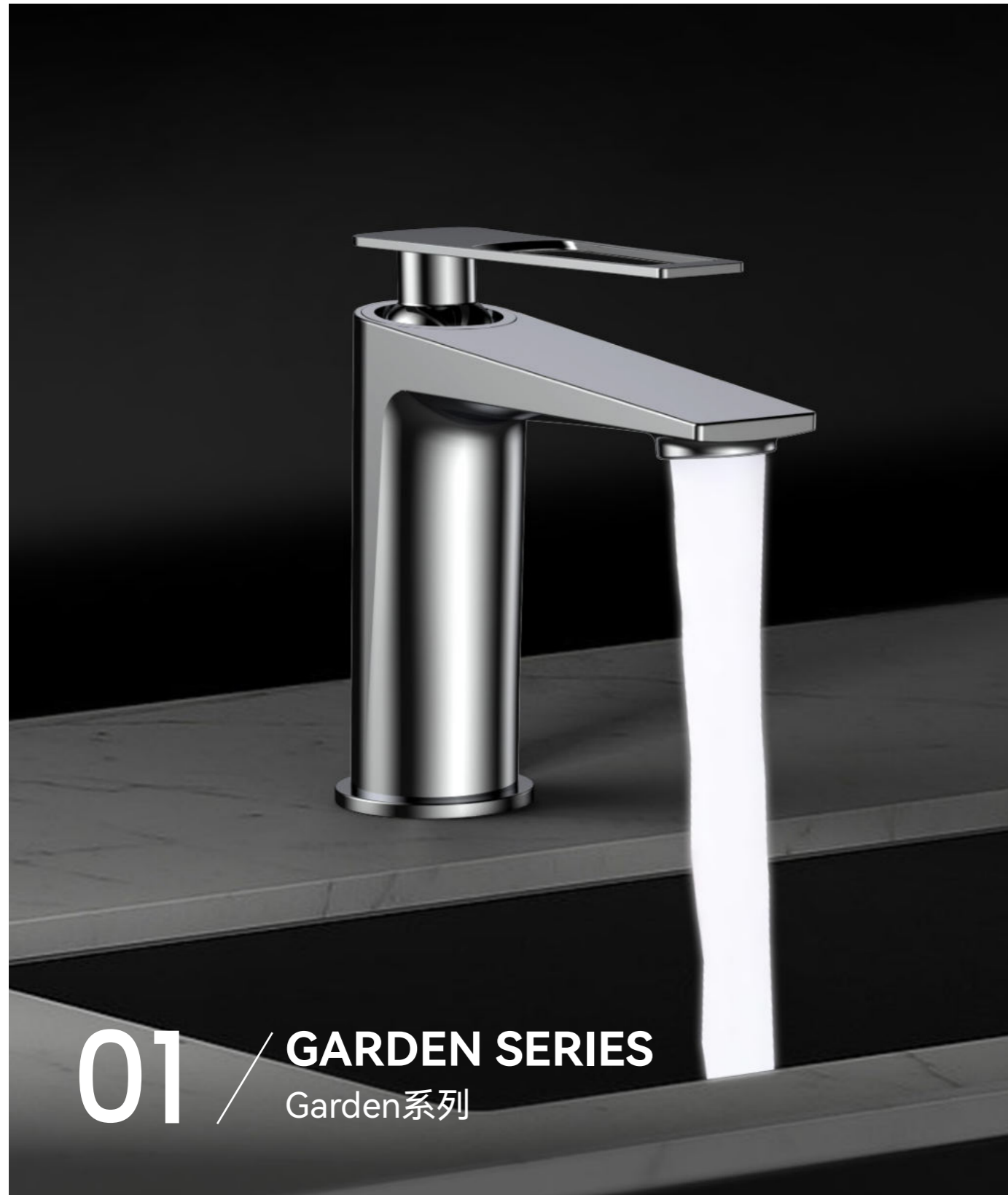

**01** / **GARDEN SERIES**  
Garden系列



本系列产品均有五色可选  
THIS SERIES OF PRODUCTS  
ARE AVAILABLE IN FIVE COLORS

**Z1T10076**

- 单把面盆龙头&Basin faucet
- 铜合金&Copper alloy



**Z1T10080**

- 单把面盆龙头&Basin faucet
- 铜合金&Copper alloy



**Z1T50001**

- 妇洗龙头&Women washing faucet
- 铜合金&Copper alloy



**Z1T30008**

- 单把淋浴龙头&Shower tap
- 铜合金&Copper alloy



**Z1T40002**

- 单把浴缸龙头&Bathtub tap
- 铜合金&Copper alloy



**Z1T30015**

- 三功能大淋浴花洒&Shower tap
- 铜合金&Copper alloy







**02 / THIN SERIES**  
Thin系列



本系列产品均有五色可选  
THIS SERIES OF PRODUCTS  
ARE AVAILABLE IN FIVE COLORS

**Z1T10059**

- 单把面盆龙头&Basin faucet
- 铜合金&Copper alloy



**Z1T10060**

- 单把面盆龙头&Basin faucet
- 铜合金&Copper alloy



**Z1T50002**

- 妇洗龙头&Women washing faucet
- 铜合金&Copper alloy



**Z1T30042**

- 单把淋浴龙头&Shower tap
- 铜合金&Copper alloy



**Z1T40003**

- 单把浴缸龙头&Bathtub tap
- 铜合金&Copper alloy



**Z1T30043**

- 大淋浴花洒&Shower tap
- 铜合金&Copper alloy



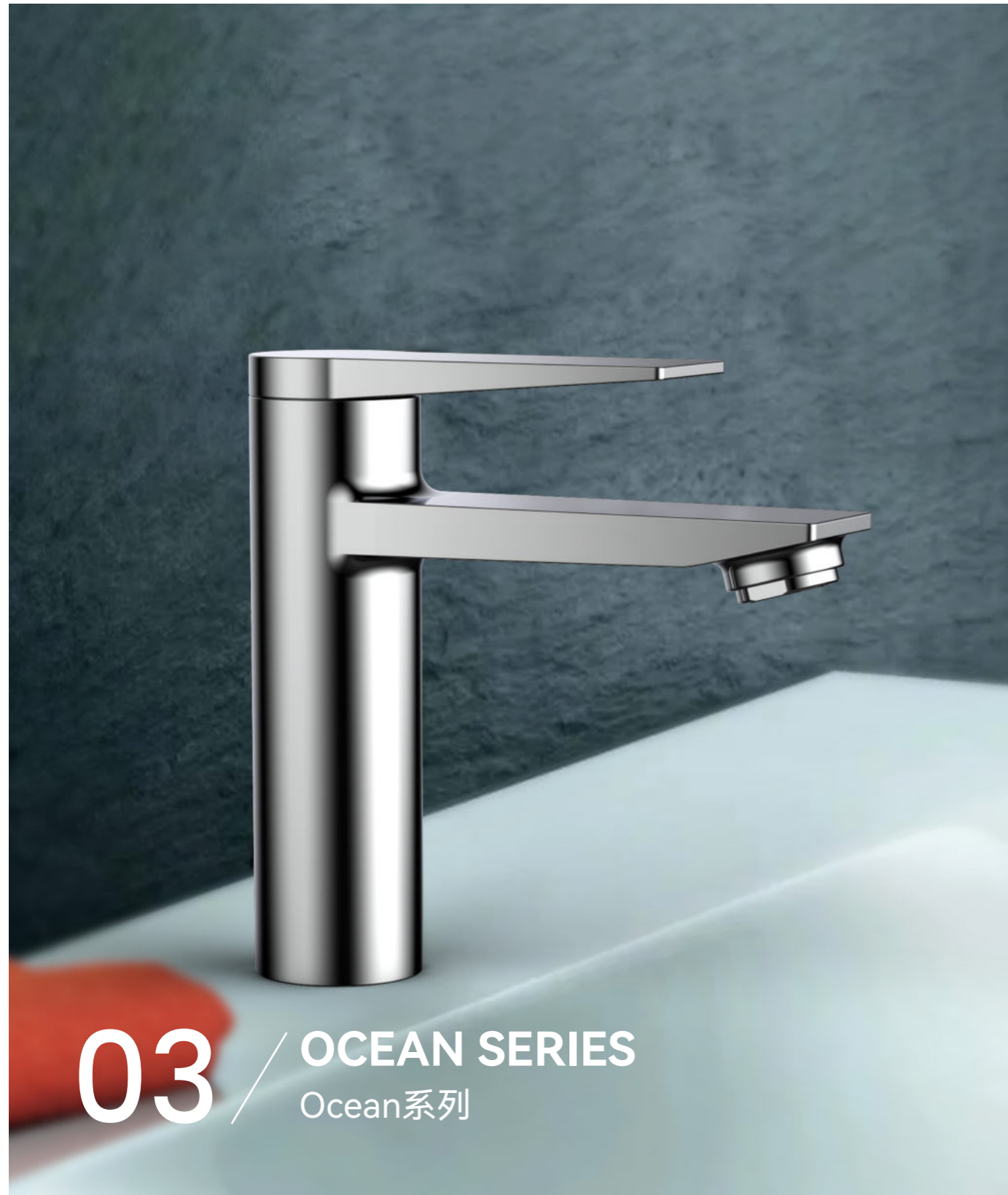

**03** / OCEAN SERIES  
Ocean系列



本系列产品均有五色可选  
THIS SERIES OF PRODUCTS  
ARE AVAILABLE IN FIVE COLORS

**Z1T10065**

- 面盆龙头&Basin faucet
- 铜合金&Copper alloy



**Z1T10066**

- 面盆龙头&Basin faucet
- 铜合金&Copper alloy



**Z1T30018**

- 淋浴龙头&Shower tap
- 铜合金&Copper alloy



**Z1T20053**

- 抽拉厨房龙头&Kitchen faucet
- 铜合金&Copper alloy



**Z1T30014**

- 淋浴龙头&Shower tap
- 铜合金&Copper alloy





**04** / **SQUARE SERIES**  
Square系列



本系列产品均有五色可选  
THIS SERIES OF PRODUCTS  
ARE AVAILABLE IN FIVE COLORS

**Z1T10077**

- 单把面盆龙头&Basin faucet
- 铜合金&Copper alloy



**Z1T10078**

- 单把面盆龙头&Basin faucet
- 铜合金&Copper alloy



**Z1T30044**

- 单把淋浴龙头&Shower tap
- 铜合金&Copper alloy



**Z1T10079**

- 8寸双把面盆龙头
- 8 "double handle basin fauce
- 铜合金&Copper alloy



**Z1T20060**

- 单把厨房龙头&Kitchen faucet
- 铜合金&Copper alloy







**05 / PASTORAL SERIES**  
Pastoral系列



本系列产品均有五色可选  
THIS SERIES OF PRODUCTS  
ARE AVAILABLE IN FIVE COLORS

**Z1T10056**

- 单把面盆龙头&Basin faucet
- 铜合金&Copper alloy



**Z1T20048**

- 单把厨房龙头&Kitchen faucet
- 铜合金&Copper alloy



**Z1T30007**

- 单把淋浴龙头&Shower tap
- 铜合金&Copper alloy



**Z1T40001**

- 单把浴缸龙头&Bathtub tap
- 铜合金&Copper alloy





**06** / **BASIN FAUCET**  
面盆龙头



本类产品均有五色可选  
THIS CATEGORY OF PRODUCTS  
ARE AVAILABLE IN FIVE COLORS

**Z1T10082**

- 单把面盆龙头&Basin faucet
- 铜合金&Copper alloy



**Z1T10083**

- 单把面盆龙头&Basin faucet
- 铜合金&Copper alloy



**Z1T10084**

- 单把面盆龙头&Basin faucet
- 铜合金&Copper alloy



**Z1T10085**

- 单把面盆龙头&Basin faucet
- 铜合金&Copper alloy



**Z1T10086**

- 单把面盆龙头&Basin faucet
- 铜合金&Copper alloy



**Z1T10058**

- 单把面盆龙头&Basin faucet
- 铜合金&Copper alloy



**Z1T10061**

- 单把面盆龙头&Basin faucet
- 铜合金&Copper alloy



**Z1T10073**

- 感应面盆龙头  
Induction basin faucet
- 铜合金&Copper alloy



**Z1T10068**

- 感应面盆龙头  
Induction basin faucet
- 铜合金&Copper alloy



**Z1T10074**

- 感应面盆龙头  
Induction basin faucet
- 铜合金&Copper alloy



**Z1T10064**

- 单把面盆龙头&Basin faucet
- 铜合金&Copper alloy



**Z1T10062**

- 双感应智能面盆龙头  
Induction basin faucet
- 铜合金&Copper alloy



**Z1T10063**

- 双感应智能面盆龙头  
Induction basin faucet
- 铜合金&Copper alloy



**Z1T10069**

- 感应面盆龙头  
Induction basin faucet
- 铜合金&Copper alloy



**Z1T10072**

- 感应面盆龙头  
Induction basin faucet
- 铜合金&Copper alloy



**Z1T10067**

- 单把面盆龙头&Basin faucet
- 铜合金&Copper alloy

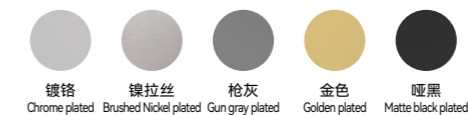
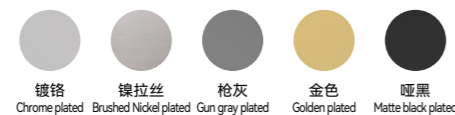





本类产品均有五色可选  
THIS CATEGORY OF PRODUCTS  
ARE AVAILABLE IN FIVE COLORS

### Z1T20055

- 抽拉厨房龙头&Kitchen faucet
- 锌合金&Zinc alloy



### Z1T20056

- 抽拉厨房龙头&Kitchen faucet
- 锌合金&Zinc alloy



### Z1T20052

- 抽拉厨房龙头&Kitchen faucet
- 铜合金&Copper alloy



### Z1T20061

- 抽拉厨房龙头&Kitchen faucet
- 铜合金&Copper alloy



### Z1T20057

- 抽拉厨房龙头&Kitchen faucet
- 锌合金&Zinc alloy



### Z1T20051

- 抽拉厨房龙头&Kitchen faucet
- 锌合金&Zinc alloy



### Z1T20062

- 抽拉厨房龙头&Kitchen faucet
- 铜合金&Copper alloy



### Z1T20063

- 抽拉厨房龙头&Kitchen faucet
- 铜合金&Copper alloy



### Z1T20059

- 抽拉厨房龙头&Kitchen faucet
- 铜合金&Copper alloy



### Z1T20058

- 抽拉厨房龙头&Kitchen faucet
- 锌合金&Zinc alloy

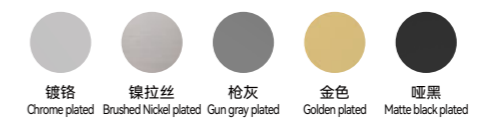
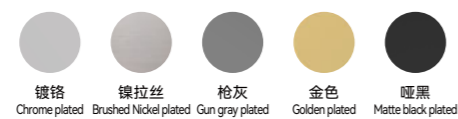



**08** / **SHOWER**  
大淋浴

**Z1T30041**

- 四功能钢琴按键淋浴花洒  
Shower tap
- 铜合金&Copper alloy



**Z1T30016**

- 四功能钢琴按键淋浴花洒  
Shower tap
- 铜合金&Copper alloy



**Z1T30027**

- 四功能钢琴按键淋浴花洒  
Shower tap
- 铜合金&Copper alloy



**Z1T30022**

- 三功能钢琴按键淋浴花洒  
Shower tap
- 铝合金&Aluminium alloy





**Z1T30037**

- 三功能钢琴按键淋浴花洒  
Shower tap
- 铜合金&Copper alloy



**Z1T30021**

- 三功能恒温大淋浴花洒  
Shower tap
- 铜合金&Copper alloy



**Z1T30028**

- 三功能大淋浴花洒  
Shower tap
- 铜合金&Copper alloy



**Z1T30017**

- 三功能大淋浴花洒  
Shower tap
- 铜合金&Copper alloy



**Z1T30040**

- 三功能大淋浴花洒  
Shower tap
- 铜合金&Copper alloy



**Z1T30020**

- 三功能大淋浴花洒  
Shower tap
- 铜合金&Copper alloy



**Z1T30019**

- 三功能大淋浴花洒  
Shower tap
- 铜合金&Copper alloy



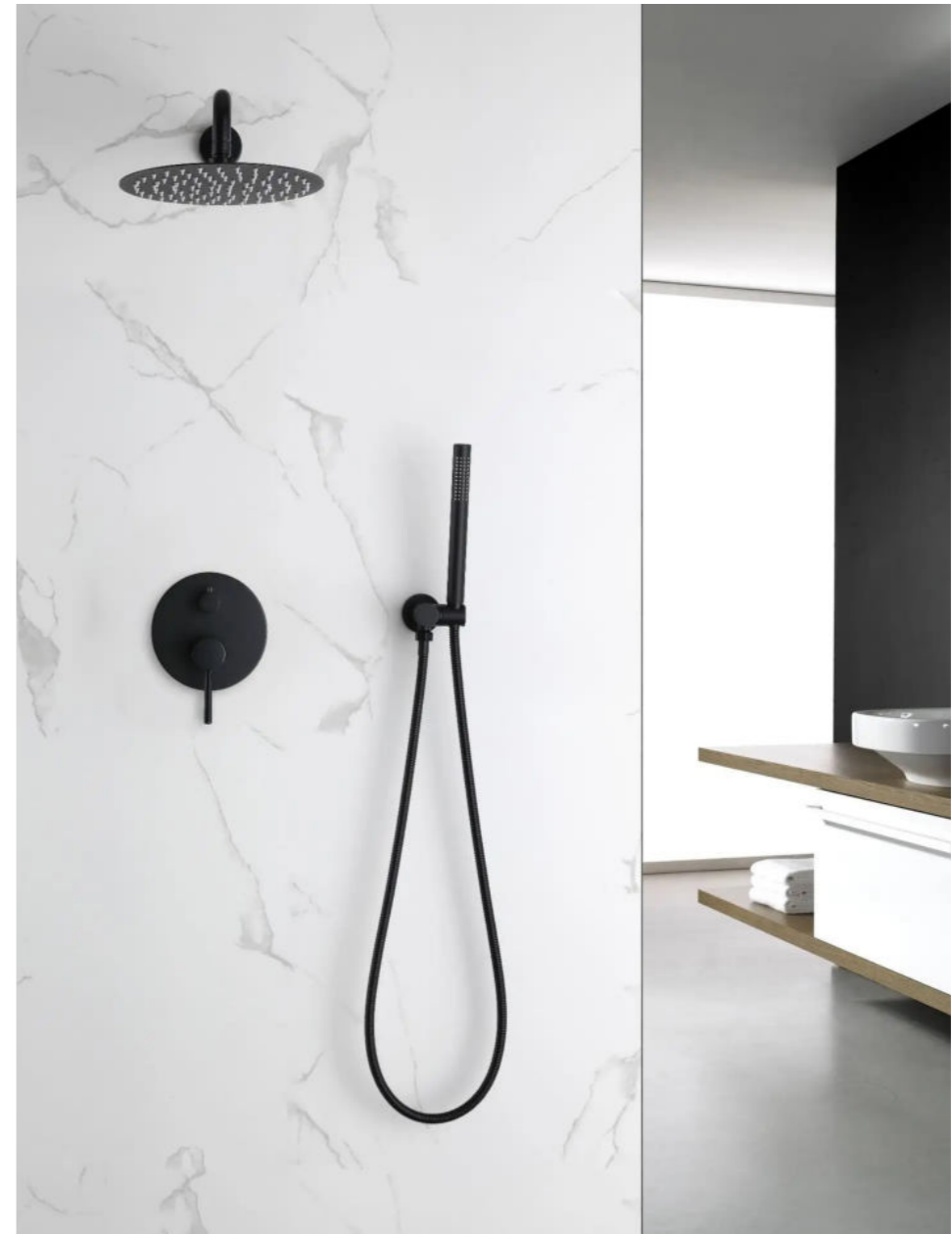

**Z1T30009**

- 三功能按键入墙淋浴龙头&Shower tap into wall
- 铜合金&Copper alloy

**Z1T30010**

- 三功能入墙淋浴龙头&Shower tap into wall
- 铜合金&Copper alloy

**Z1T30033**

- 三功能入墙淋浴龙头&Shower tap into wall
- 铜合金&Copper alloy

**Z1T30035**

- 三功能入墙淋浴龙头&Shower tap into wall
- 铜合金&Copper alloy

**Z1T30011**

- 两功能入墙淋浴龙头&Shower tap into wall
- 铜合金&Copper alloy

**Z1T30036**

- 三功能入墙淋浴龙头&Shower tap into wall
- 铜合金&Copper alloy

**Z1T30034**

- 两功能按键入墙淋浴龙头&Shower tap into wall
- 铜合金&Copper alloy





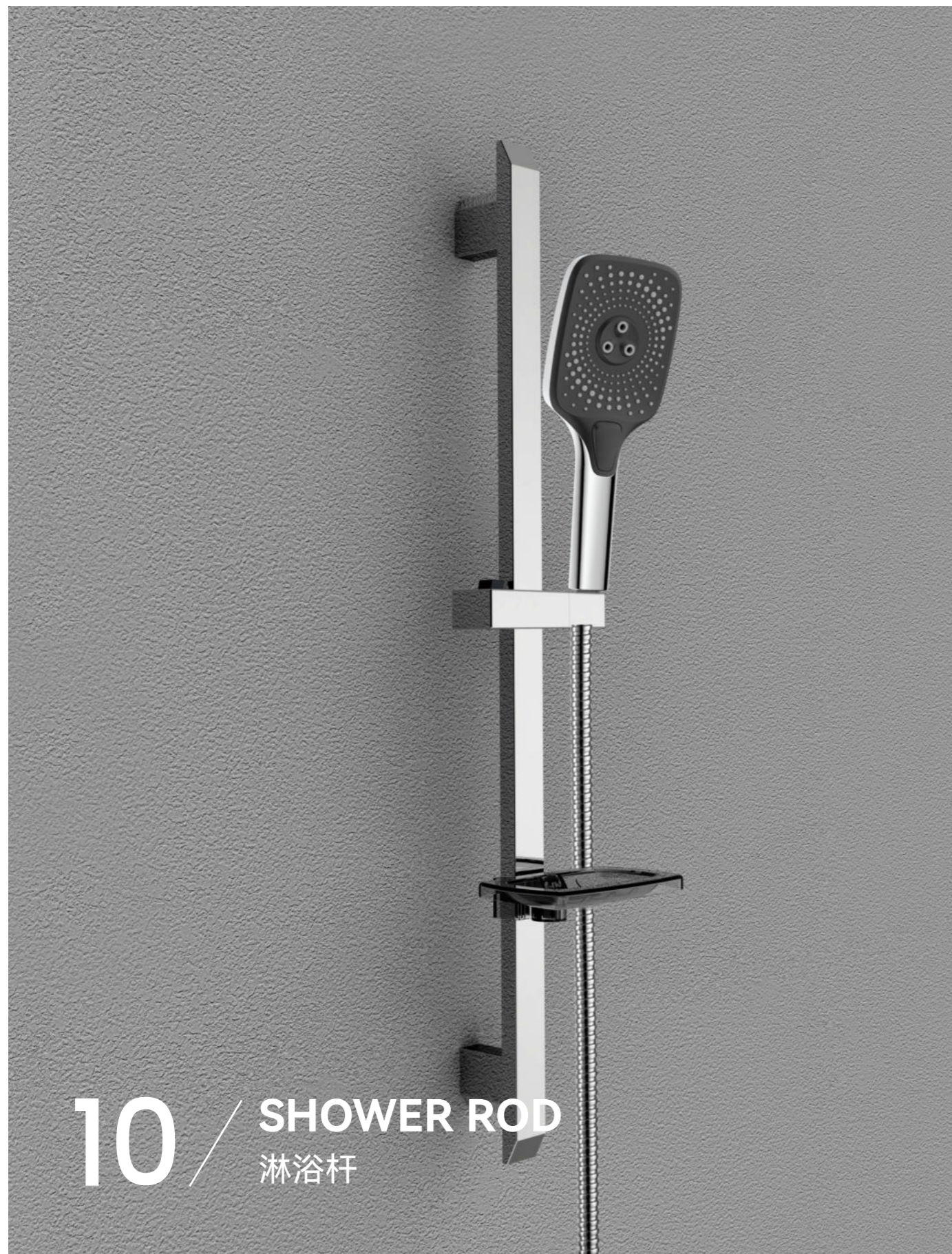

**10** / **SHOWER ROD**  
淋浴杆

**Z1T30039**

- 淋浴杆&Shower rod
- SUS201



**Z1T30038**

- 淋浴杆&Shower rod
- SUS201



**Z1T30025**

- 淋浴杆&Shower rod
- 铜合金&Copper alloy



**Z1T30026**

- 淋浴杆&Shower rod
- 铜合金&Copper alloy







**11** / **AMERICAN STYLE FAUCET**  
美式龙头

**Z1T10070**

- 4寸双把面盆龙头
- 4 "double handle basin faucet
- 铜合金&Copper alloy



**Z1T10057**

- 4寸双把面盆龙头
- 4 "double handle basin faucet
- 铜合金&Copper alloy



**Z1T10004**

- 4寸双把面盆龙头
- 4 "double handle basin faucet
- 铜合金&Copper alloy



**Z1T10015**

- 4寸双把面盆龙头
- 4 "double handle basin faucet
- 铜合金&Copper alloy

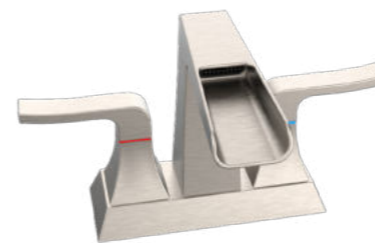

**Z1T10005**

- 4寸双把面盆龙头
- 4 "double handle basin faucet
- 铜合金&Copper alloy



**Z1T10006**

- 4寸双把面盆龙头
- 4 "double handle basin faucet
- 铜合金&Copper alloy



### Z1T10007

- 4寸双把面盆龙头
- 4 "double handle basin faucet
- 铜合金&Copper alloy



### Z1T10008

- 4寸双把面盆龙头
- 4 "double handle basin faucet
- 铜合金&Copper alloy



### Z1T10009

- 4寸双把面盆龙头
- 4 "double handle basin faucet
- 铜合金&Copper alloy



### Z1T10012

- 8寸双把面盆龙头
- 8 "double handle basin faucet
- 铜合金&Copper alloy



### Z1T10013

- 8寸双把面盆龙头
- 8 "double handle basin faucet
- 铜合金&Copper alloy



### Z1T10014

- 8寸双把面盆龙头
- 8 "double handle basin faucet
- 铜合金&Copper alloy



### Z1T10010

- 4寸双把面盆龙头
- 4 "double handle basin faucet
- 铜合金&Copper alloy



### Z1T10003

- 8寸双把面盆龙头
- 8 "double handle basin faucet
- 铜合金&Copper alloy



### Z1T10071

- 8寸双把面盆龙头
- 8 "double handle basin faucet
- 铜合金&Copper alloy



### Z1T20054

- 抽拉厨房龙头&Kitchen faucet
- 铜合金&Copper alloy



### Z1T20064

- 抽拉感应厨房龙头
- Pull induction kitchen faucet
- 铜合金&Copper alloy



### Z1T20001

- 抽拉厨房龙头&Kitchen faucet
- 铜合金&Copper alloy

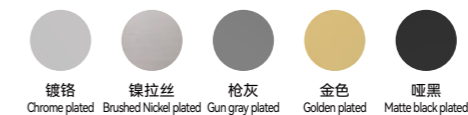

### Z1T20002

- 抽拉厨房龙头&Kitchen faucet
- 铜合金&Copper alloy



### Z1T30029

- 入墙淋浴龙头&Shower tap into wall
- 铜合金&Copper alloy



### Z1T30032

- 入墙淋浴龙头&Shower tap into wall
- 铜合金&Copper alloy



### Z1T30012

- 入墙淋浴龙头&Shower tap into wall
- 铜合金&Copper alloy



### Z1T30030

- 入墙淋浴龙头&Shower tap into wall
- 铜合金&Copper alloy



### Z1T30031

- 入墙淋浴龙头&Shower tap into wall
- 铜合金&Copper alloy



### Z1T30013

- 入墙淋浴龙头&Shower tap into wall
- 铜合金&Copper alloy





# BATHROOM PENDANT

浴室挂件

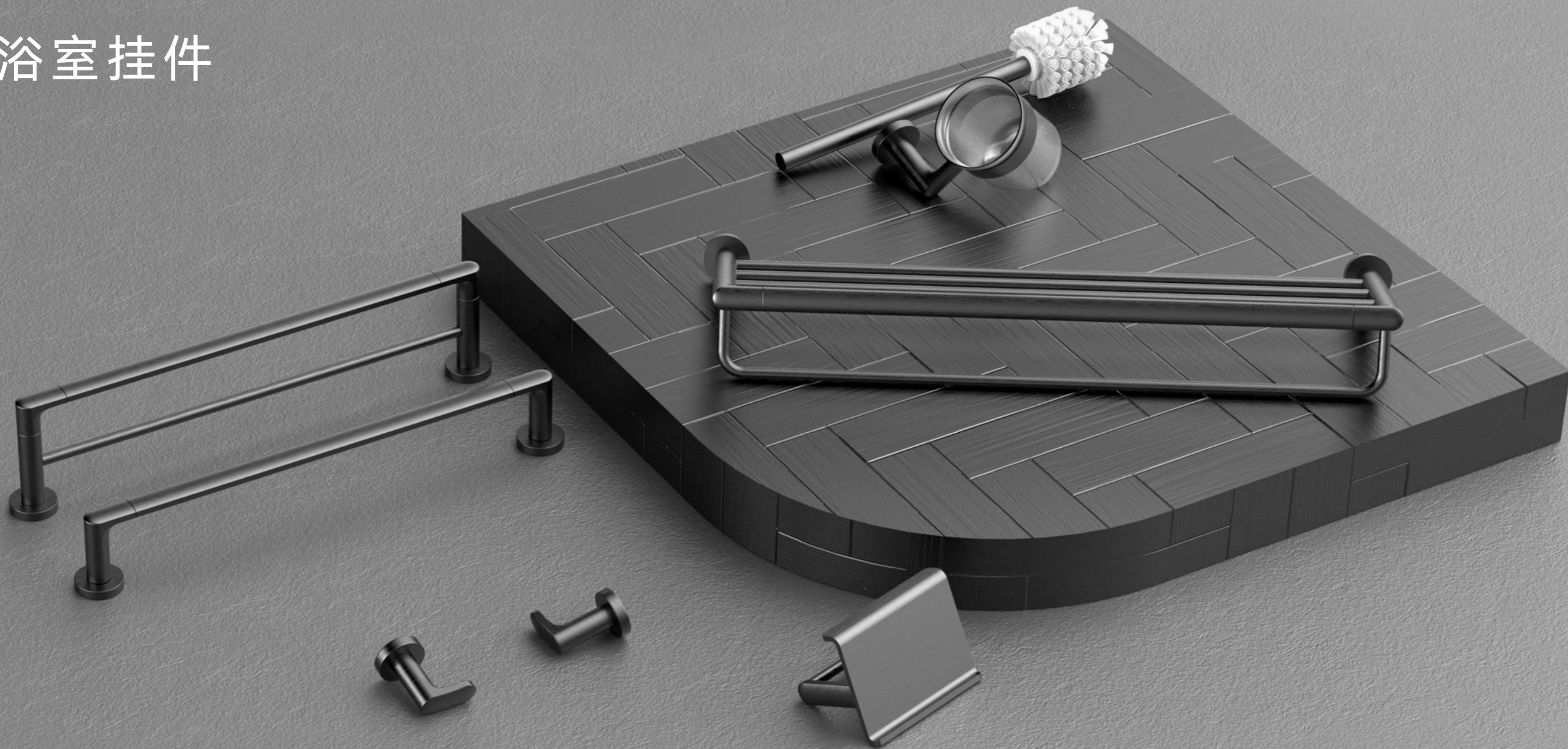

龙头类 / 浴室挂件 / 排杆 / 地漏 / 软管 / 水嘴角阀 / 安全扶手





**01 / KNURL SERIES PENDANT**  
Knurl系列挂件



本系列产品均有五色可选  
THIS SERIES OF PRODUCTS  
ARE AVAILABLE IN FIVE COLORS

**Z1Y20010**

- 18"单杆毛巾杆&18"towel bar
- 铝合金&Aluminium alloy



**Z1Y20011**

- 24"毛巾杆&24"towel bar
- 铝合金&Aluminium alloy



**Z1Y50001**

- 衣钩&Coat hook
- 铝合金&Aluminium alloy

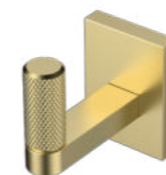

**Z1Y00010**

- 纸巾架&Paper towel holde
- 铝合金&Aluminium alloy

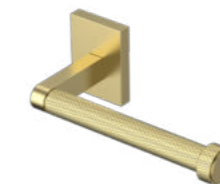

**Z1Y20012**

- 毛巾环&Towel ring
- 铝合金&Aluminium alloy





**02 / LAUREL SERIES PENDANT**  
Laurel系列挂件



本系列产品均有五色可选  
THIS SERIES OF PRODUCTS  
ARE AVAILABLE IN FIVE COLORS

**Z1Y20020**

- 18"单杆毛巾杆&18"towel bar
- 锌合金&Zinc alloy



**Z1Y20021**

- 24"毛巾杆&24"towel bar
- 锌合金&Zinc alloy



**Z1Y10005**

- 纸巾架&Paper towel holde
- 锌合金&Zinc alloy



**Z1Y20022**

- 毛巾环&Towel ring
- 锌合金&Zinc alloy



**Z1Y50007**

- 衣钩&Coat hook
- 锌合金&Zinc alloy







**03** / **MERCER SERIES PENDANT**  
Mercer系列挂件



本系列产品均有五色可选  
THIS SERIES OF PRODUCTS  
ARE AVAILABLE IN FIVE COLORS

**Z1Y20017**

- 18"单杆毛巾杆&18"towel bar
- 锌合金&Zinc alloy



**Z1Y20018**

- 24"毛巾杆&24"towel bar
- 锌合金&Zinc alloy

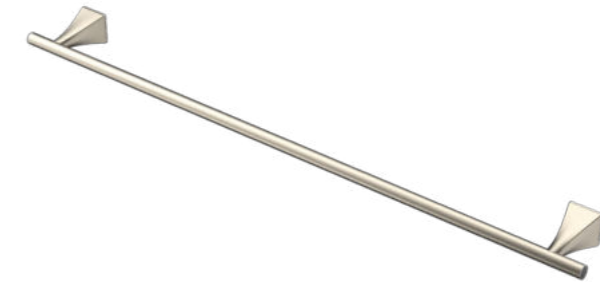

**Z1Y10004**

- 纸巾架&Paper towel holde
- 锌合金&Zinc alloy



**Z1Y20019**

- 毛巾环&Towel ring
- 锌合金&Zinc alloy



**Z1Y50006**

- 衣钩&Coat hook
- 锌合金&Zinc alloy





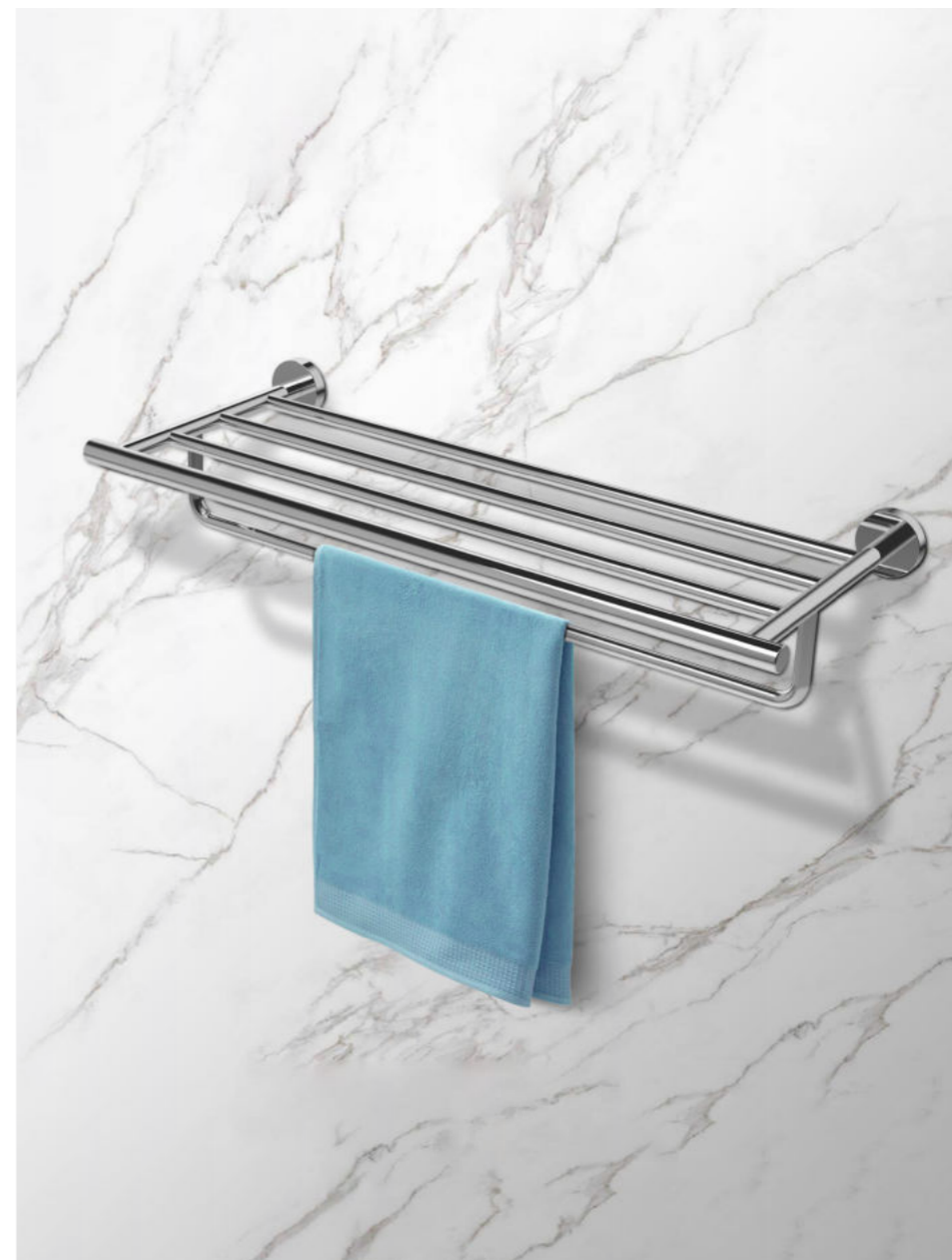

本系列产品均有五色可选  
THIS SERIES OF PRODUCTS  
ARE AVAILABLE IN FIVE COLORS

**Z1Y20001**

- 24"毛巾杆&24"towel bar
- SUS304

**Z1Y20002**

- 24"毛巾杆&24"towel
- SUS304

**Z1Y20028**

- 毛巾架&Towel rack
- SUS304

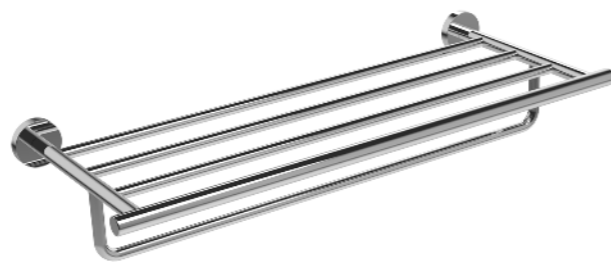
**Z1Y80001**

- 漱口杯&Mouthwash cup
- SUS304

**Z1Y10006**

- 纸巾架&Paper towel holde
- SUS304

**Z1Y40001**

- 香皂碟架&Soap tray holder
- SUS304

**Z1Y20003**

- 毛巾环&Towel ring
- SUS304

**Z1Y30001**

- 马桶刷架&Toilet brush holder
- SUS304

**Z1Y50008**

- 衣钩&Coat hook
- SUS304





**05 / SIMPLE SERIES PENDANT**  
Simple系列挂件



本系列产品均有五色可选  
THIS SERIES OF PRODUCTS  
ARE AVAILABLE IN FIVE COLORS

**Z1Y20027**

- 24"毛巾杆&24"towel bar
- 铝合金&Aluminium alloy



**Z1Y20028**

- 毛巾杆&towel bar
- 铝合金&Aluminium alloy



**Z1Y10011**

- 纸巾架&Paper towel holde
- 铝合金&Aluminium alloy



**Z1Y50010**

- 衣钩&Coat hook
- 铝合金&Aluminium alloy



**Z1Y40002**

- 香皂碟架&Soap tray holder
- 铝合金&Aluminium alloy



**Z1Y80002**

- 漱口杯&Mouthwash cup
- 铝合金&Aluminium alloy







**06 / ELEGANT SERIES PENDANT**  
Elegant系列挂件



本系列产品均有五色可选  
THIS SERIES OF PRODUCTS  
ARE AVAILABLE IN FIVE COLORS

**Z1Y20031**

- 24"毛巾杆&24"towel bar
- 铝合金&Aluminium alloy



**Z1Y20032**

- 毛巾环&Towel ring
- 铝合金&Aluminium alloy



**Z1Y50012**

- 衣钩&Coat hook
- 铝合金&Aluminium alloy



**Z1Y40004**

- 香皂碟架&Soap tray holder
- 铝合金&Aluminium alloy



**Z1Y80004**

- 漱口杯&Mouthwash cup
- 铝合金&Aluminium alloy



**Z1Y10014**

- 纸巾架&Paper towel holde
- 铝合金&Aluminium alloy







**07 / ROME SERIES PENDANT**  
Rome系列挂件



本系列产品均有五色可选  
THIS SERIES OF PRODUCTS  
ARE AVAILABLE IN FIVE COLORS

**Z1Y20033**

- 24"毛巾杆&24"towel bar
- 铝合金&Aluminium alloy



**Z1Y20034**

- 毛巾环&Towel ring
- 铝合金&Aluminium alloy



**Z1Y10013**

- 纸巾架&Paper towel holde
- 铝合金&Aluminium alloy



**Z1Y50013**

- 衣钩&Coat hook
- 铝合金&Aluminium alloy



**Z1Y40005**

- 香皂碟架&Soap tray holder
- 铝合金&Aluminium alloy



**Z1Y80005**

- 漱口杯&Mouthwash cup
- 铝合金&Aluminium alloy





**08** / **GLACIER SERIES PENDANT**  
Glacier系列挂件



本系列产品均有五色可选  
THIS SERIES OF PRODUCTS  
ARE AVAILABLE IN FIVE COLORS

**Z1Y20035**

- 24"毛巾杆&24"towel bar
- 铝合金&Aluminium alloy



**Z1Y20036**

- 24"毛巾杆&24"towel bar
- 铝合金&Aluminium alloy



**Z1Y20037**

- 浴巾架&bath towel holder
- 铝合金&Aluminium alloy



**Z1Y70001**

- 双层置物架&Double shelving
- 铝合金&Aluminium alloy



**Z1Y10014**

- 纸巾架&Paper towel holde
- 铝合金&Aluminium alloy





**09 / PLAIN SERIES PENDANT**  
Plain系列挂件



本系列产品均有五色可选  
THIS SERIES OF PRODUCTS  
ARE AVAILABLE IN FIVE COLORS

**Z1Y20038**

- 24"毛巾杆&24"towel bar
- 铝合金&Aluminium alloy



**Z1Y20039**

- 24"毛巾杆&24"towel bar
- 铝合金&Aluminium alloy



**Z1Y20040**

- 浴巾架&bath towel holder
- 铝合金&Aluminium alloy

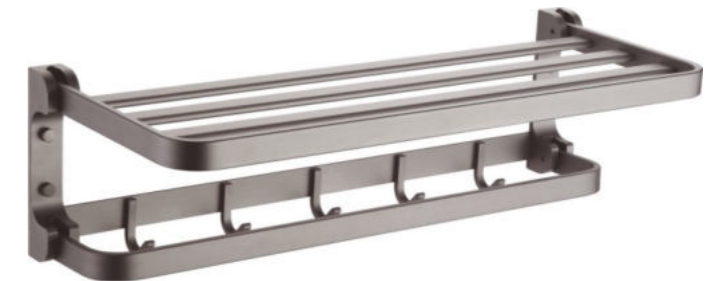

**Z1Y70002**

- 双层置物架&Double shelving
- 铝合金&Aluminium alloy



**Z1Y10015**

- 纸巾架&Paper towel holde
- 铝合金&Aluminium alloy







# FAUCET POP-UP







排杆

龙头类 / 浴室挂件 / 排杆 / 地漏 / 软管 / 水嘴角阀 / 安全扶手





**01** / **PULL-UP TYPE POP-UP**  
 提拉式去水

-   
 镀铬  
Chrome plated
-   
 金色  
Golden plated
-   
 镍拉丝  
Brushed Nickel plated
-   
 古铜色  
Oil rubbed bronze
-   
 哑黑  
Matte black plated
-   
 可定制  
Customizable

本类产品均有六色可选  
 THIS CATEGORY OF PRODUCTS  
 ARE AVAILABLE IN SIX COLORS

**Z1P10001**

- 提拉式去水&Pull-up type POP-UP
- 铜合金&Copper alloy
- $\phi 54*202*1\ 1/2-18UNEF-2A$



**Z1P10002**

- 提拉式去水&Pull-up type POP-UP
- 铜合金&Copper alloy
- $\phi 60*202*1\ 1/2-18UNEF-2A$



**Z1P10003**

- 提拉式去水&Pull-up type POP-UP
- SUS304
- $\phi 54*202*1\ 1/2-18UNEF-2A$



**Z1P10004**

- 提拉式去水&Pull-up type POP-UP
- SUS304
- $\phi 60*202*1\ 1/2-18UNEF-2A$



### Z1P10005

- 提拉式去水&Pull-up type POP-UP
- SUS304
- $\phi 58 \times 188 \times 1 \frac{1}{4}$ -18UNEF-2A



### Z1P10006

- 提拉式去水&Pull-up type POP-UP
- SUS304
- $\phi 58 \times 207 \times 1 \frac{1}{2}$ -18UNEF-2A



### Z1P10010

- 提拉式去水&Pull-up type POP-UP
- SUS304
- $\phi 53.6 \times 214.5 \times 1.38$ -18UNEF-2A



### Z1P10011

- 提拉式去水&Pull-up type POP-UP
- 塑料&Plastic
- $\phi 54.5 \times 227.5 \times 1.38$ -12UN F-2A



### Z1P10007

- 提拉式去水&Pull-up type POP-UP
- 铜合金&Copper alloy
- $\phi 52.5 \times 223 \times 1 \frac{1}{4}$ -18UNEF-2A



### Z1P10009

- 提拉式去水&Pull-up type POP-UP
- 塑料&Plastic
- $\phi 60 \times 222 \times 1 \frac{7}{16}$ -12UN-2A



### Z1P10012

- 提拉式去水&Pull-up type POP-UP
- 塑料&Plastic
- $\phi 60 \times 220 \times 1 \frac{7}{16}$ -12UN-2A

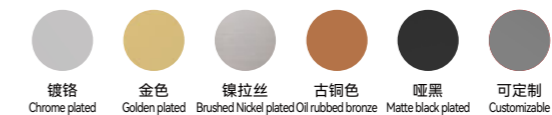
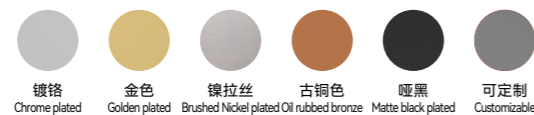



**02 / BOUNCE POP-UP**  
弹跳式去水

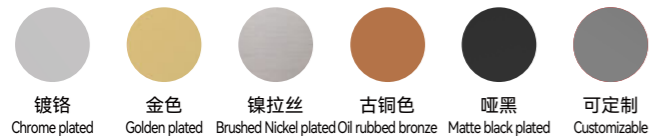

本类产品均有六色可选  
THIS CATEGORY OF PRODUCTS  
ARE AVAILABLE IN SIX COLORS

**Z1P20001**

- 弹跳式去水&Bounce POP-UP
- 铜合金&Copper alloy



**Z1P20002**

- 弹跳式去水&Bounce POP-UP
- 铜合金&Copper alloy
- $\phi 54 \times 202 \times 1.38-18 \text{UNEF}-2\text{A}$



**Z1P20003**

- 弹跳式去水&Bounce POP-UP
- 铜合金&Copper alloy
- $\phi 60 \times 207.5 \times 1 \frac{1}{2}-18 \text{UNEF}-2\text{A}$



**Z1P20004**

- 弹跳式去水&Bounce POP-UP
- 铜合金&Copper alloy





### Z1P20005

- 弹跳式去水&Bounce POP-UP
- 铜合金&Copper alloy



### Z1P20007

- 弹跳式去水&Bounce POP-UP
- SUS304



### Z1P20010

- 弹跳式去水&Bounce POP-UP
- SUS304



### Z1P20012

- 弹跳式去水&Bounce POP-UP
- SUS304



### Z1P20008

- 弹跳式去水&Bounce POP-UP
- SUS304
- $\phi 58 * 1 \frac{1}{2}$ -18UNEF-2A



### Z1P20009

- 弹跳式去水&Bounce POP-UP
- SUS304



### Z1P20013

- 弹跳式去水&Bounce POP-UP
- SUS304



### Z1P20015

- 弹跳式去水&Bounce POP-UP
- SUS304

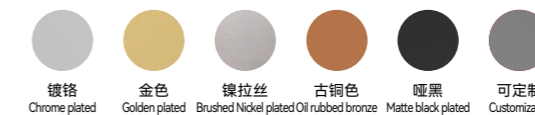
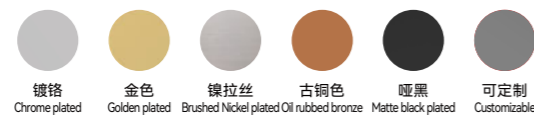

### Z1P20017

- 弹跳式去水&Bounce POP-UP
- 塑料&Plastic
- $\phi 62 * G1 1/4B$



### Z1P20018

- 弹跳式去水&Bounce POP-UP
- 塑料&Plastic
- $\phi 61 * 165.5 * G1 1/4B$



### Z1P20028

- 弹跳式去水&Bounce POP-UP
- 铜合金&Copper alloy



### Z1P20031

- 弹跳式去水&Bounce POP-UP
- 铜合金&Copper alloy



### Z1P20019

- 弹跳式去水&Bounce POP-UP
- 塑料&Plastic



### Z1P20021

- 弹跳式去水&Bounce POP-UP
- 塑料&Plastic



### Z1P20036

- 弹跳式去水&Bounce POP-UP
- SUS304



### Z1P20037

- 弹跳式去水&Bounce POP-UP
- SUS304

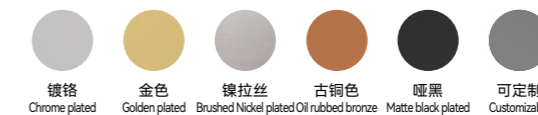
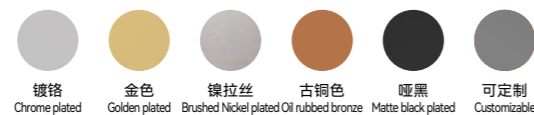

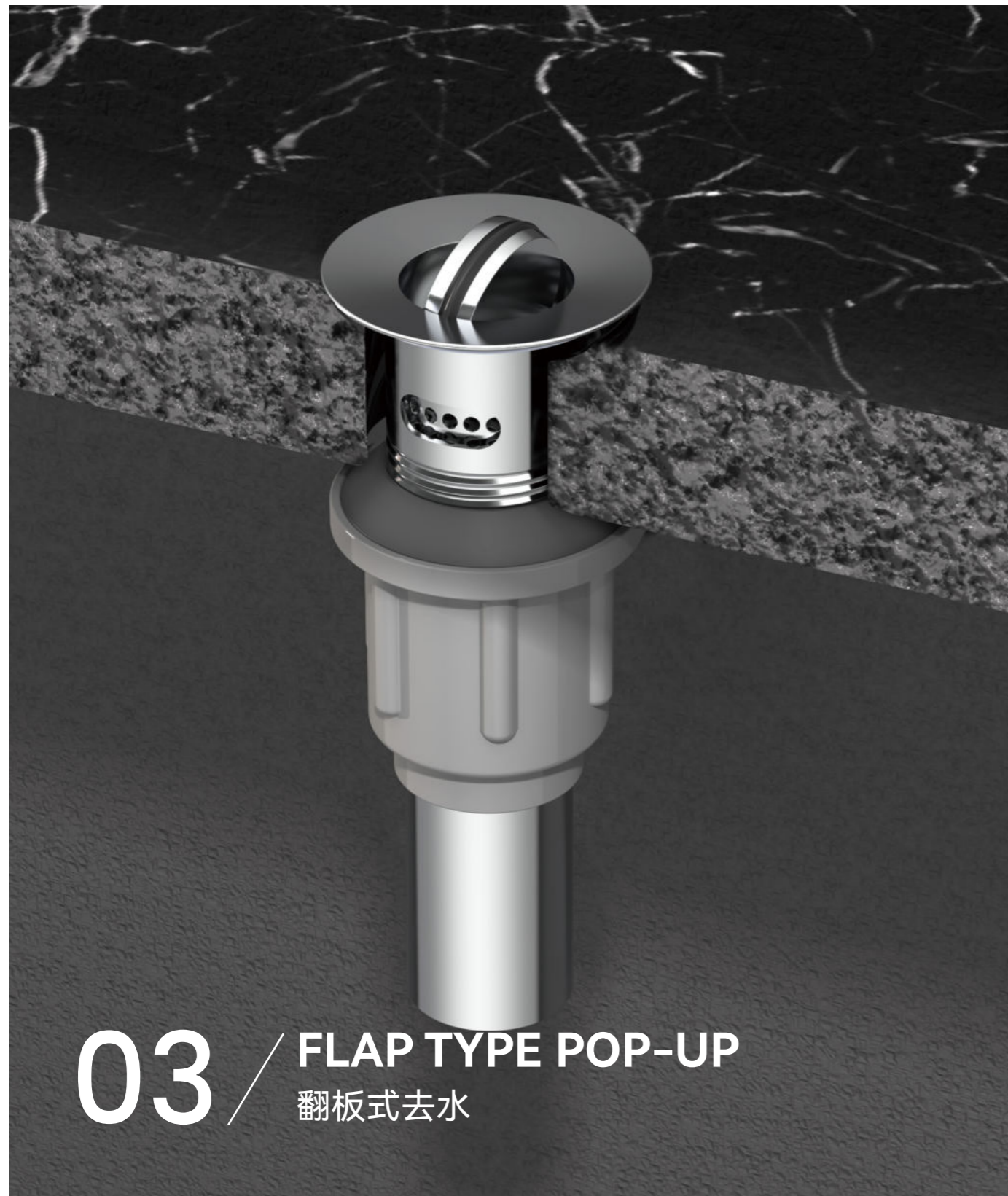

**03** / **FLAP TYPE POP-UP**  
翻板式去水

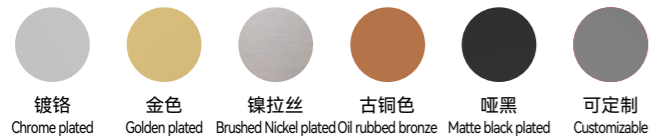

镀铬    金色    镍拉丝    古铜色    哑黑    可定制  
 Chrome plated    Golden plated    Brushed Nickel plated    Oil rubbed bronze    Matte black plated    Customizable

本类产品均有六色可选  
 THIS CATEGORY OF PRODUCTS  
 ARE AVAILABLE IN SIX COLORS

**Z1P30001**

- 翻板式去水  
Flap type POP-UP
- SUS304



**Z1P30002**

- 翻板式去水  
Flap type POP-UP
- SUS304



**Z1P30003**

- 翻板式去水  
Flap type POP-UP
- SUS304



**Z1P30004**

- 翻板式去水  
Flap type POP-UP
- SUS304



**Z1P30005**

- 翻板式去水&Flap type POP-UP
- SUS304



**Z1P30007**

- 翻板式去水&Flap type POP-UP
- SUS304



**Z1P30010**





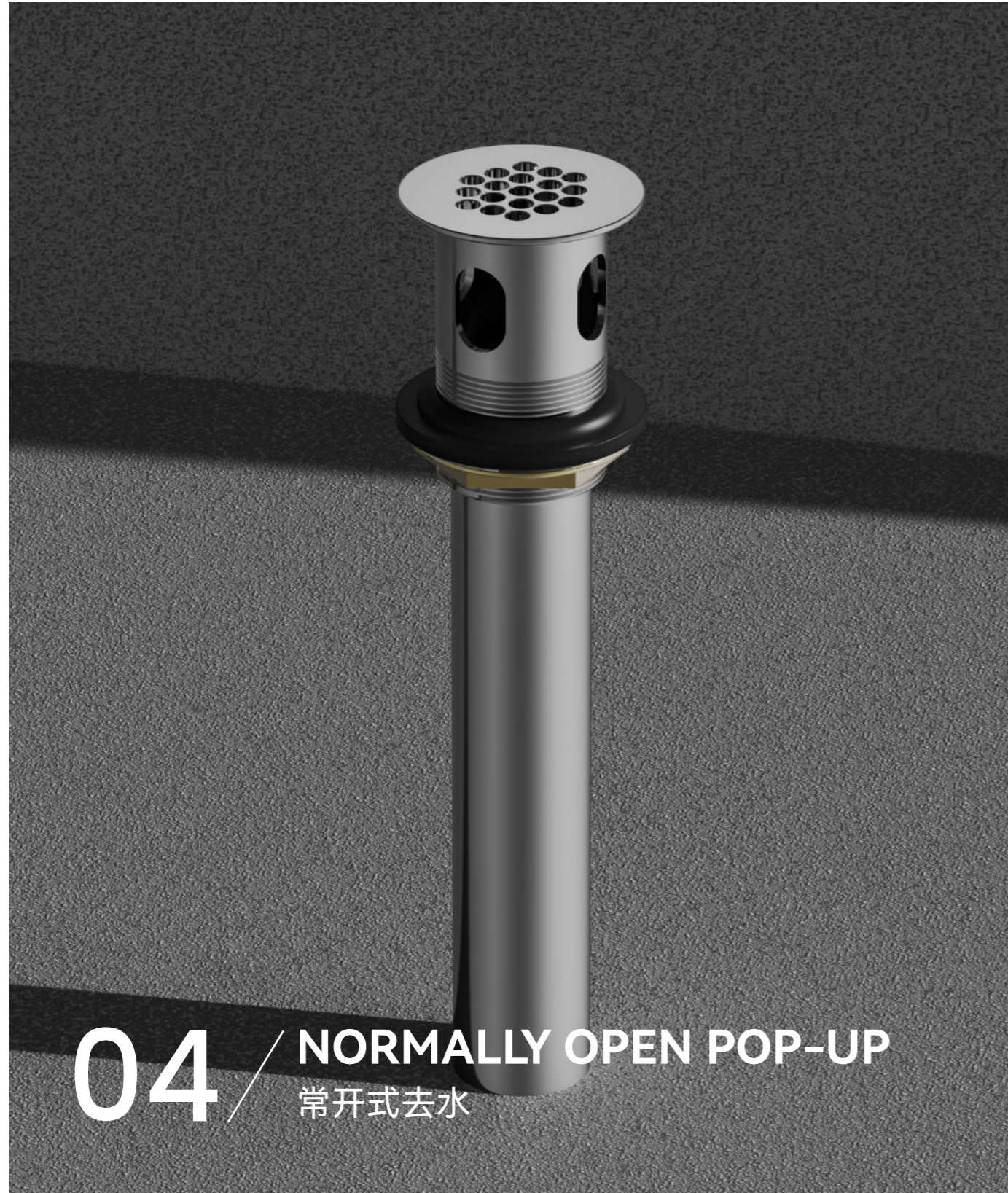

- 翻板式去水&Flap type POP-UP
- SUS304







**04 / NORMALLY OPEN POP-UP**  
常开式去水

-   
镀铬  
Chrome plated
-   
金色  
Golden plated
-   
镍拉丝  
Brushed Nickel plated
-   
古铜色  
Oil rubbed bronze
-   
哑黑  
Matte black plated
-   
可定制  
Customizable

本类产品均有六色可选  
THIS CATEGORY OF PRODUCTS  
ARE AVAILABLE IN SIX COLORS

**Z1P40001**

- 常开式去水  
Normally open POP-UP
- 铜合金&Copper alloy



**Z1P40002**

- 常开式去水  
Normally open POP-UP
- 铜合金&Copper alloy



**Z1P40003**

- 常开式去水  
Normally open POP-UP
- 铜合金&Copper alloy



**Z1P40004**

- 常开式去水  
Normally open POP-UP
- 铜合金&Copper alloy



**Z1P40005**

- 常开式去水  
Normally open POP-UP
- 铜合金&Copper alloy



**Z1P40006**

- 常开式去水  
Normally open POP-UP
- 铜合金&Copper alloy







**05 / GUYED POP-UP**  
拉线式去水

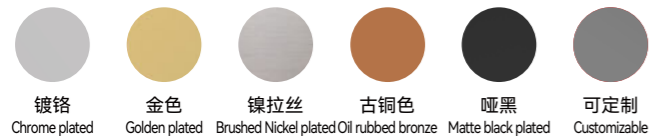

本类产品均有六色可选  
THIS CATEGORY OF PRODUCTS  
ARE AVAILABLE IN SIX COLORS

**Z1P50001**

- 拉线式去水&Guyed POP-UP
- 塑料&Plastic
- $\phi 54*192*1$  5/16-18UNEF-2A



**Z1P50005**

- 拉线式去水&Guyed POP-UP
- 铜合金&Copper alloy
- $\phi 54*192*1$  5/16-18UNEF-2A



**Z1P50003**

- 拉线式去水&Guyed POP-UP
- 铜合金&Copper alloy
- $\phi 54*192*1$  5/16-18UNEF-2A







**06 / INTELLIGENT CONTROL POP-UP**  
智能控制去水

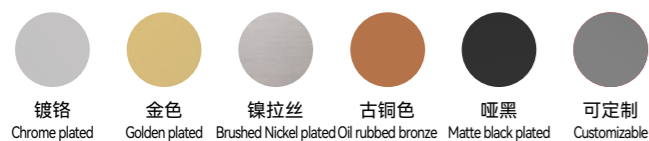

本类产品均有六色可选  
THIS CATEGORY OF PRODUCTS  
ARE AVAILABLE IN SIX COLORS

**Z1P60001**

- 触控式智能控制去水  
Touch intelligent control POP-UP
- 铜合金&Copper alloy
- $\phi 54*192*1$  5/16-18UNEF-2A



**Z1P60002**

- 红外感应式智能控制去水  
Infrared intelligent control POP-UP
- 铜合金&Copper alloy
- $\phi 54*192*1$  5/16-18UNEF-2A







### Z1P70001

- 欧式去水&European style POP-UP
- 铜合金&Copper alloy



### Z1P70002

- 欧式去水&European style POP-UP
- 铜合金&Copper alloy



### Z1P70003

- 欧式去水&European style POP-UP
- 铜合金&Copper alloy



### Z1P70004

- 欧式去水&European style POP-UP
- 铜合金&Copper alloy



### Z1P70005

- 欧式去水&European style POP-UP
- 铜合金/塑料&Copper alloy/Plastic



### Z1P70006

- 欧式去水&European style POP-UP
- 铜合金/塑料&Copper alloy/Plastic

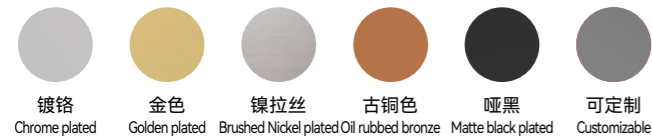

本类产品均有六色可选  
THIS CATEGORY OF PRODUCTS  
ARE AVAILABLE IN SIX COLORS



# 08 / VEGETABLE POTS POP-UP

菜盆去水

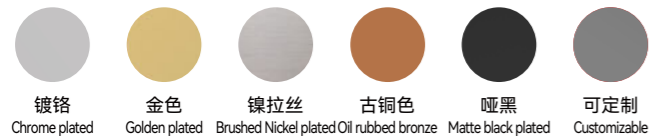

本类产品均有六色可选  
THIS CATEGORY OF PRODUCTS  
ARE AVAILABLE IN SIX COLORS

## Z1P80001

- 菜盆去水  
Vegetable pots POP-UP
- 铜合金&Copper alloy



## Z1P80002

- 菜盆去水  
Vegetable pots POP-UP
- 铜合金&Copper alloy



## Z1P80003

- 菜盆去水  
Vegetable pots POP-UP
- 铜合金&Copper alloy



## Z1P80004

- 菜盆去水  
Vegetable pots POP-UP
- 铜合金&Copper alloy



## Z1P80005

- 菜盆去水  
Vegetable pots POP-UP
- 铜合金&Copper alloy



## Z1P80006

- 菜盆去水  
Vegetable pots POP-UP
- 铜合金&Copper alloy





**09** / **BATHTUB POP-UP**  
浴缸去水

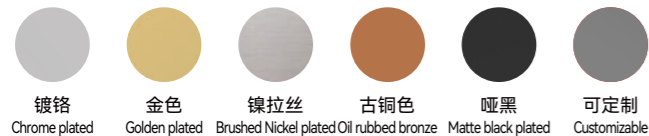

本类产品均有六色可选  
THIS CATEGORY OF PRODUCTS  
ARE AVAILABLE IN SIX COLORS

**Z1P90001**

- 手轮拉线式浴缸去水  
Hand wheel pull type POP-UP
- 铜合金&Copper alloy



**Z1P90002**

- 手轮拉线式浴缸去水  
Hand wheel pull type POP-UP
- 铜合金&Copper alloy



**Z1P90003**

- 手轮拉线式浴缸去水  
Hand wheel pull type POP-UP
- 铜合金&Copper alloy



**Z1P90004**

- 手轮拉线式浴缸去水  
Hand wheel pull type POP-UP
- 塑料&Plastic





**Z1P90005**

- 手轮拉线式浴缸去水  
Hand wheel pull type POP-UP
- 塑料&Plastic



**Z1P90006**

- 手轮拉线式浴缸去水  
Hand wheel pull type POP-UP
- 塑料&Plastic



**Z1P90101**

- 弹跳式浴缸去水  
Bounce POP-UP
- 铜合金&Copper alloy



**Z1P90105**

- 弹跳式浴缸去水  
Bounce POP-UP
- 塑料&Plastic



**Z1P90201**

- 珠链式浴缸去水  
Bead chain POP-UP
- 铜合金&Copper alloy



**Z1P90202**

- 珠链式浴缸去水  
Bead chain POP-UP
- 铜合金&Copper alloy



**Z1P90102**

- 弹跳式浴缸去水  
Bounce POP-UP
- 铜合金&Copper alloy



**Z1P90103**

- 弹跳式浴缸去水  
Bounce POP-UP
- 塑料&Plastic



**Z1P90104**

- 弹跳式浴缸去水  
Bounce POP-UP
- 塑料&Plastic



**Z1P90203**

- 珠链式浴缸去水  
Bead chain POP-UP
- 铜合金&Copper alloy



**Z1P90204**

- 珠链式浴缸去水  
Bead chain POP-UP
- 塑料&Plastic



**Z1P90205**

- 珠链式浴缸去水  
Bead chain POP-UP
- 塑料&Plastic

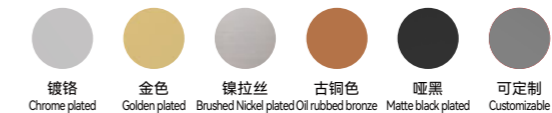
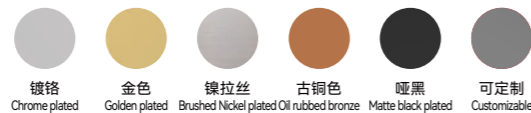

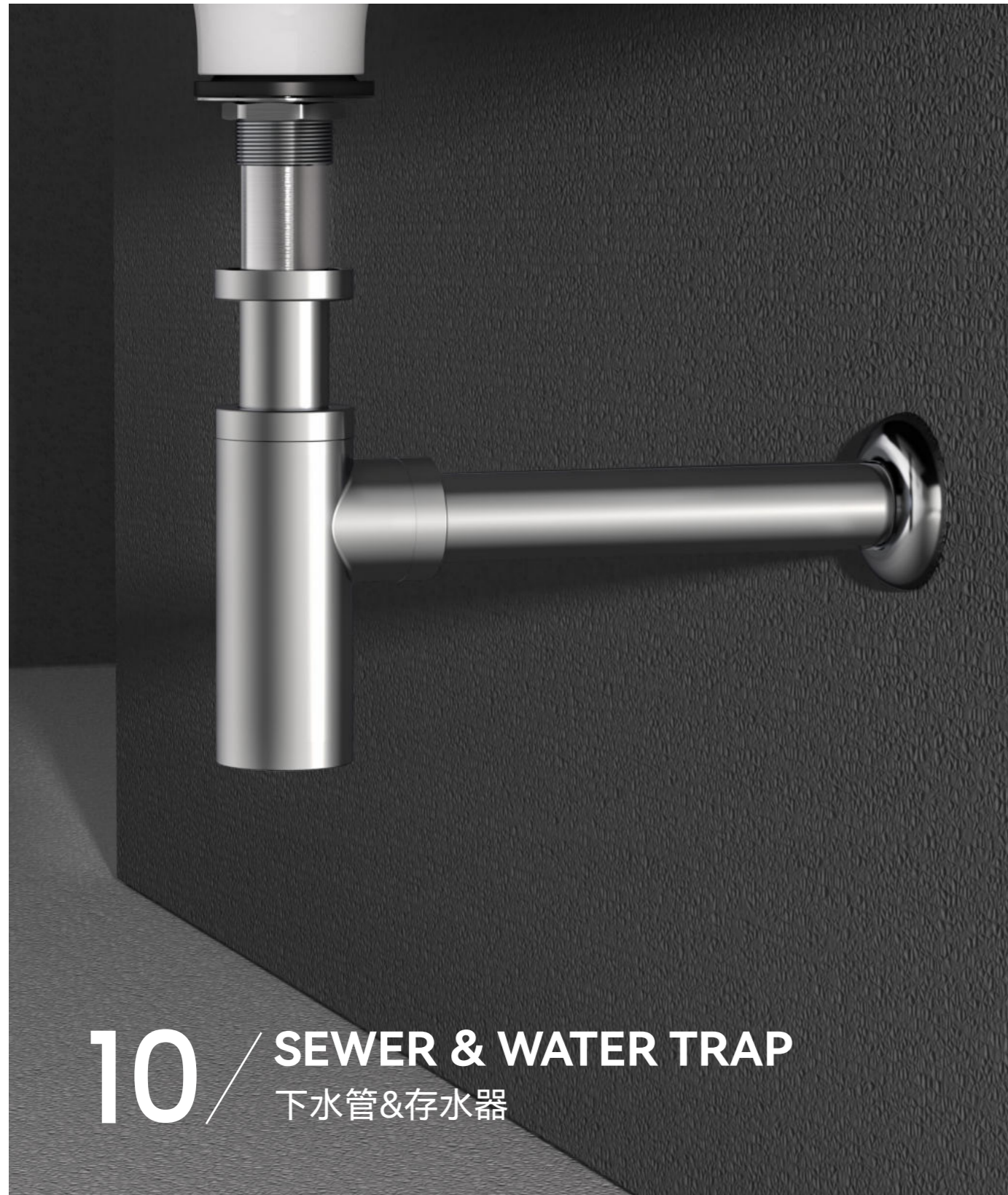

**10 / SEWER & WATER TRAP**  
下水管&存水器

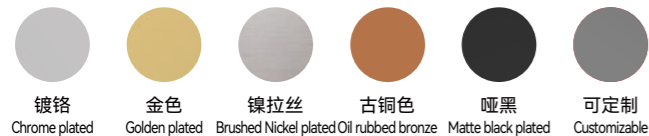

本类产品均有六色可选  
THIS CATEGORY OF PRODUCTS  
ARE AVAILABLE IN SIX COLORS

**Z1P11001**

- P弯&S弯  
P bend & S bend
- 铜合金&Copper alloy



**Z1P11003**

- P弯&S弯  
P bend & S bend
- 铜合金&Copper alloy



**Z1P11004**

- P弯&S弯  
P bend & S bend
- 铜合金&Copper alloy



**Z1P11005**

- P弯&S弯  
P bend & S bend
- 铜合金&Copper alloy



**Z1P11006**

- P弯&S弯  
P bend & S bend
- 铜合金&Copper alloy



**Z1P11008**

- P弯&S弯  
P bend & S bend
- 铜合金&Copper alloy



### Z1P11101

- 水封式存水器  
Water sealed water trap
- 铜合金&Copper alloy



### Z1P11103

- 水封式存水器  
Water sealed water trap
- 铜合金&Copper alloy



### Z1P11104

- 水封式存水器  
Water sealed water trap
- 铜合金&Copper alloy



### Z1P11109

- 水封式存水器  
Water sealed water trap
- 铜合金&Copper alloy



### Z1P11110

- 水封式存水器  
Water sealed water trap
- 铜合金&Copper alloy



### Z1P11111

- 水封式存水器  
Water sealed water trap
- 铜合金&Copper alloy



### Z1P11105

- 水封式存水器  
Water sealed water trap
- 铜合金&Copper alloy



### Z1P11106

- 水封式存水器  
Water sealed water trap
- 铜合金&Copper alloy



### Z1P11107

- 水封式存水器  
Water sealed water trap
- 铜合金&Copper alloy



### Z1P11112

- 水封式存水器  
Water sealed water trap
- 铜合金&Copper alloy



### Z1P11113

- 水封式存水器  
Water sealed water trap
- 铜合金&Copper alloy



### Z1P11114

- 水封式存水器  
Water sealed water trap
- 铜合金&Copper alloy

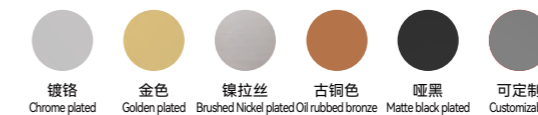
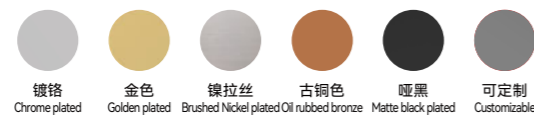



# FLOORDRAIN

地漏

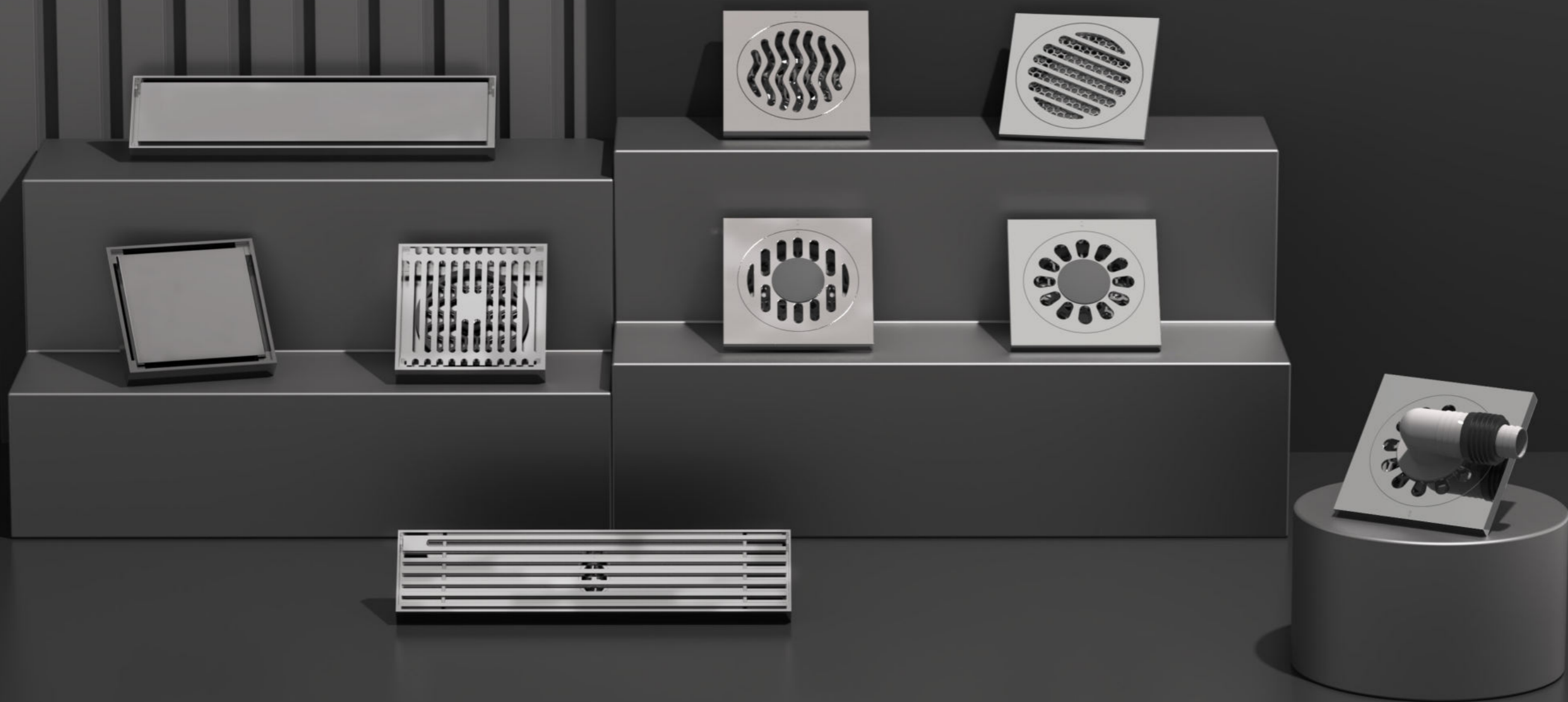

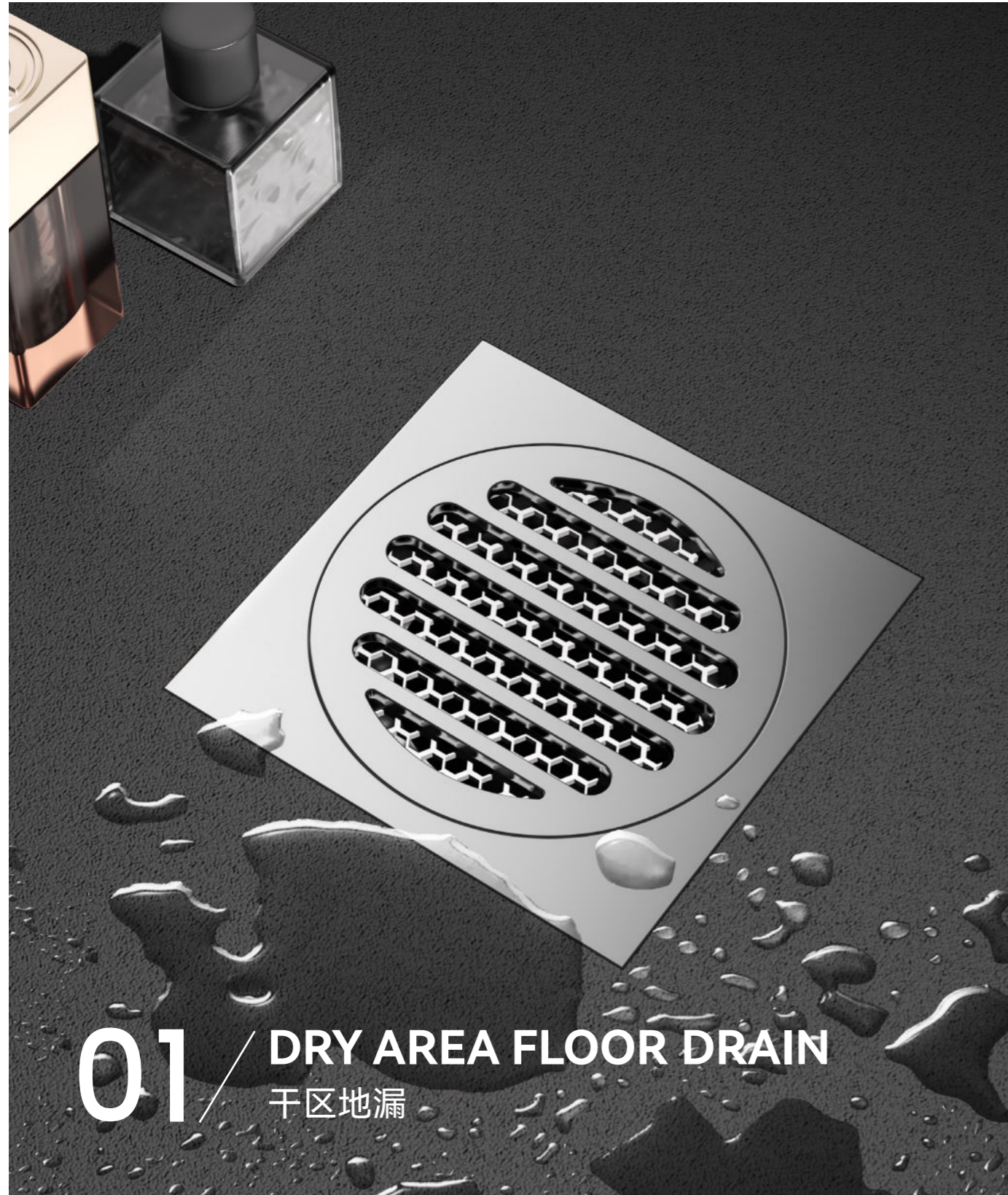

**01 / DRY AREA FLOOR DRAIN**  
干区地漏

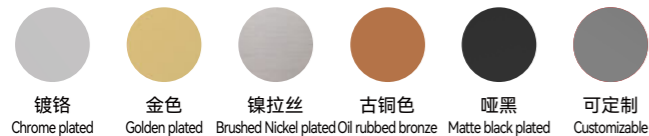

本类产品均有六色可选  
THIS CATEGORY OF PRODUCTS  
ARE AVAILABLE IN SIX COLORS

**Z1D11001**

- 干区地漏&Dry area floor drain
- 铜合金&Copper alloy



**Z1D11002**

- 干区地漏&Dry area floor drain
- 铜合金&Copper alloy



**Z1D11003**

- 干区地漏&Dry area floor drain
- 铜合金&Copper alloy



**Z1D11004**

- 干区地漏&Dry area floor drain
- 铜合金&Copper alloy



**Z1D11005**

- 干区地漏&Dry area floor drain
- SUS304



**Z1D11008**

- 干区地漏&Dry area floor drain
- 铜合金&Copper alloy













# 02 / WASHING MACHINE FLOOR DRAIN

## 洗衣机地漏

-   
镀铬  
Chrome plated
-   
金色  
Golden plated
-   
镍拉丝  
Brushed Nickel plated
-   
古铜色  
Oil rubbed bronze
-   
哑黑  
Matte black plated
-   
可定制  
Customizable

本类产品均有六色可选  
THIS CATEGORY OF PRODUCTS  
ARE AVAILABLE IN SIX COLORS

### Z1D12001

- 洗衣机地漏&Washing machine floor drain
- 铜合金&Copper alloy



### Z1D12002

- 洗衣机地漏&Washing machine floor drain
- SUS304



### Z1D12003

- 洗衣机地漏&Washing machine floor drain
- 铜合金&Copper alloy



### Z1D12004

- 洗衣机地漏&Washing machine floor drain
- SUS304



### Z1D12006

- 洗衣机地漏&Washing machine floor drain
- SUS304



### Z1D12007

- 洗衣机地漏&Washing machine floor drain
- 铜合金&Copper alloy





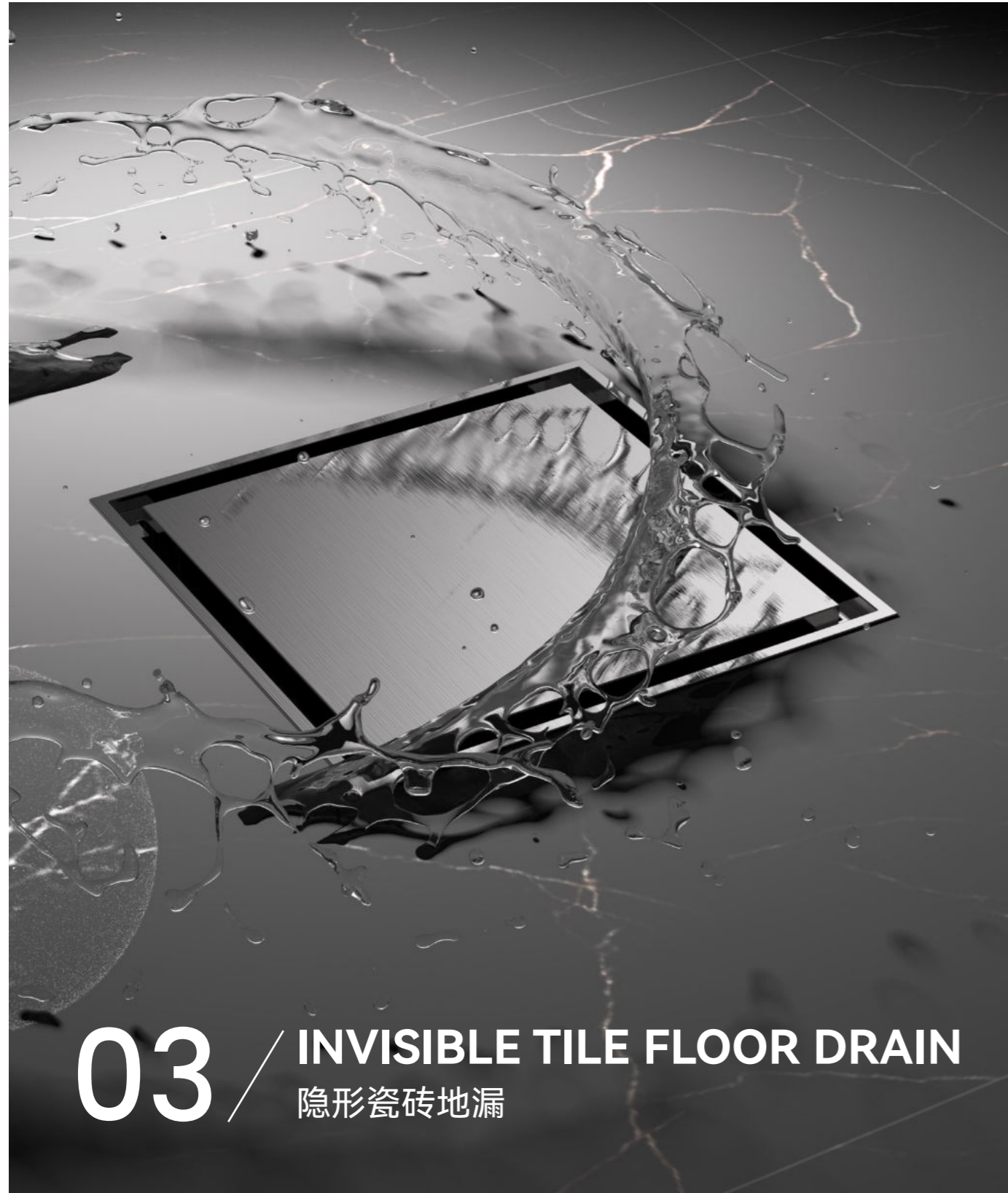

# 03 / INVISIBLE TILE FLOOR DRAIN

## 隐形瓷砖地漏

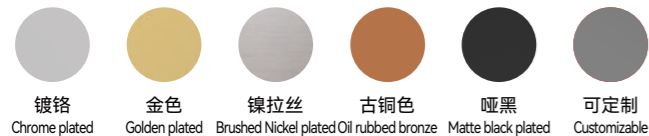

本类产品均有六色可选  
THIS CATEGORY OF PRODUCTS  
ARE AVAILABLE IN SIX COLORS

### Z1D13001

- 隐形瓷砖地漏&Invisible tile floor drain
- 铜合金&Copper alloy

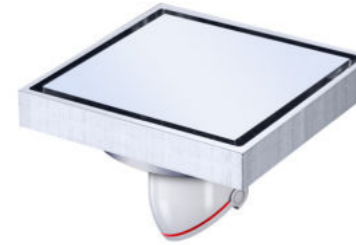

### Z1D13002

- 隐形瓷砖地漏&Invisible tile floor drain
- SUS304



### Z1D13003

- 隐形瓷砖地漏&Invisible tile floor drain
- 铜合金&Copper alloy

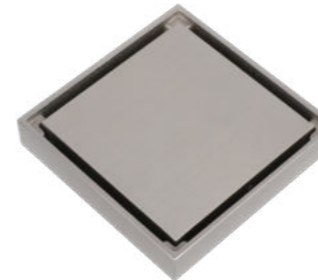

### Z1D13004

- 隐形瓷砖地漏&Invisible tile floor drain
- 铜合金&Copper alloy



### Z1D13005

- 隐形瓷砖地漏&Invisible tile floor drain
- SUS304







# 04 / SHOWER FLOOR DRAIN

## 淋浴地漏

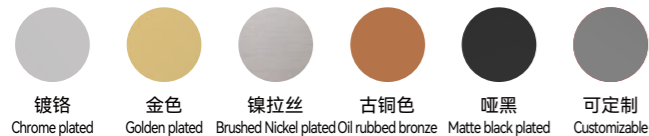

本类产品均有六色可选  
THIS CATEGORY OF PRODUCTS  
ARE AVAILABLE IN SIX COLORS

### Z1D14001

- 淋浴地漏&Shower floor drain
- 铜合金&Copper alloy



### Z1D14002

- 淋浴地漏&Shower floor drain
- 铜合金&Copper alloy



### Z1D14004

- 淋浴地漏&Shower floor drain
- 铜合金&Copper alloy



### Z1D14005

- 淋浴地漏&Shower floor drain
- 铜合金&Copper alloy



### Z1D14006

- 淋浴地漏&Shower floor drain
- 铜合金&Copper alloy



### Z1D14007

- 淋浴地漏&Shower floor drain
- 铜合金&Copper alloy





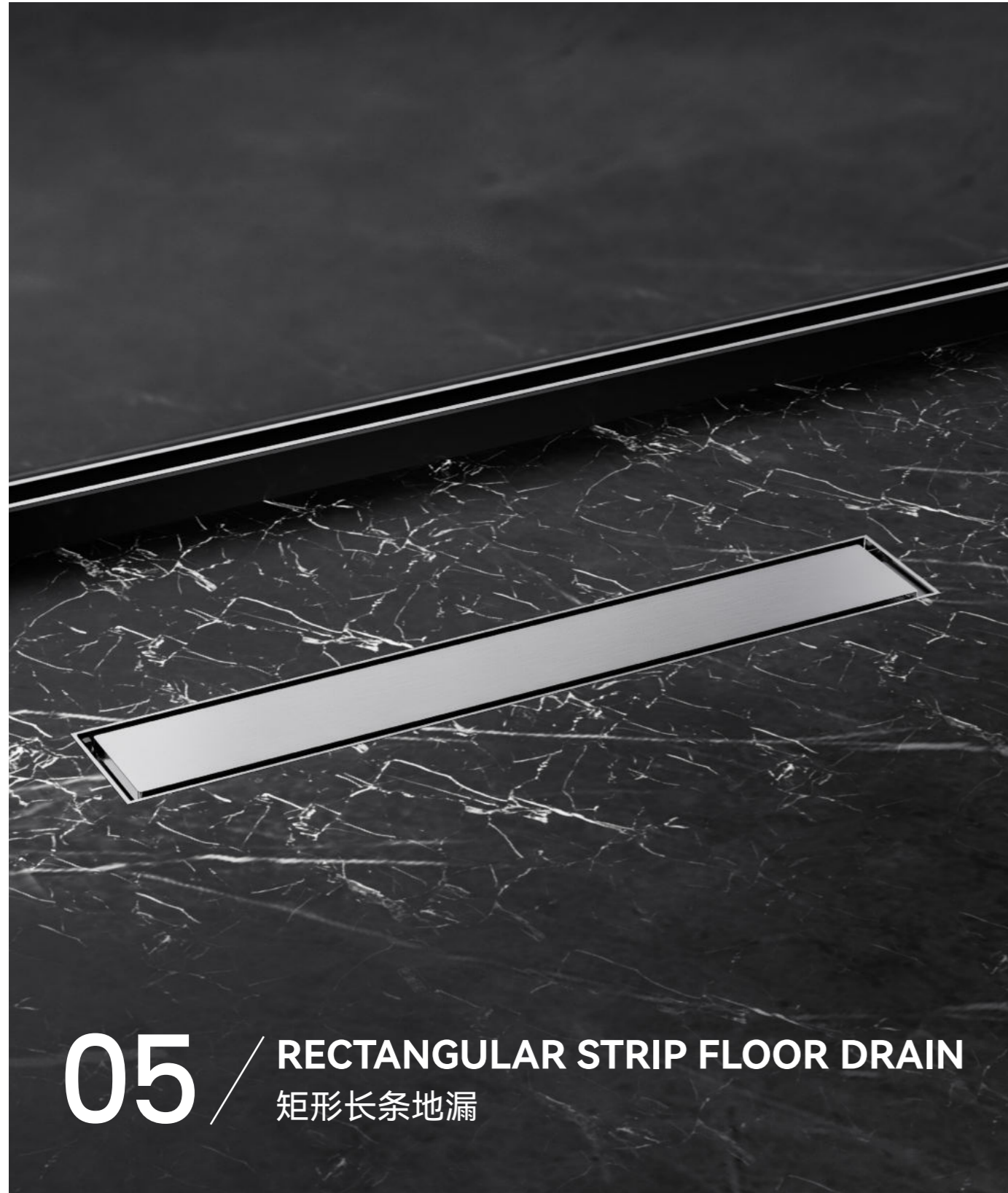

**05** / **RECTANGULAR STRIP FLOOR DRAIN**  
 矩形长条地漏

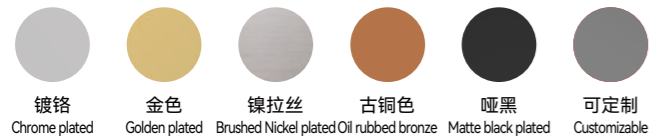

本类产品均有六色可选  
 THIS CATEGORY OF PRODUCTS  
 ARE AVAILABLE IN SIX COLORS

**Z1D15001**

- 矩形长条地漏  
Rectangular strip floor drain
- 铜合金&Copper alloy



**Z1D15002**

- 矩形长条地漏  
Rectangular strip floor drain
- 铜合金&Copper alloy



**Z1D15004**

- 矩形长条地漏  
Rectangular strip floor drain
- SUS304



**Z1D15005**

- 矩形长条地漏  
Rectangular strip floor drain
- SUS304







# HOSE

软管

龙头类 / 浴室挂件 / 排杆 / 地漏 / 软管 / 水嘴角阀 / 安全扶手



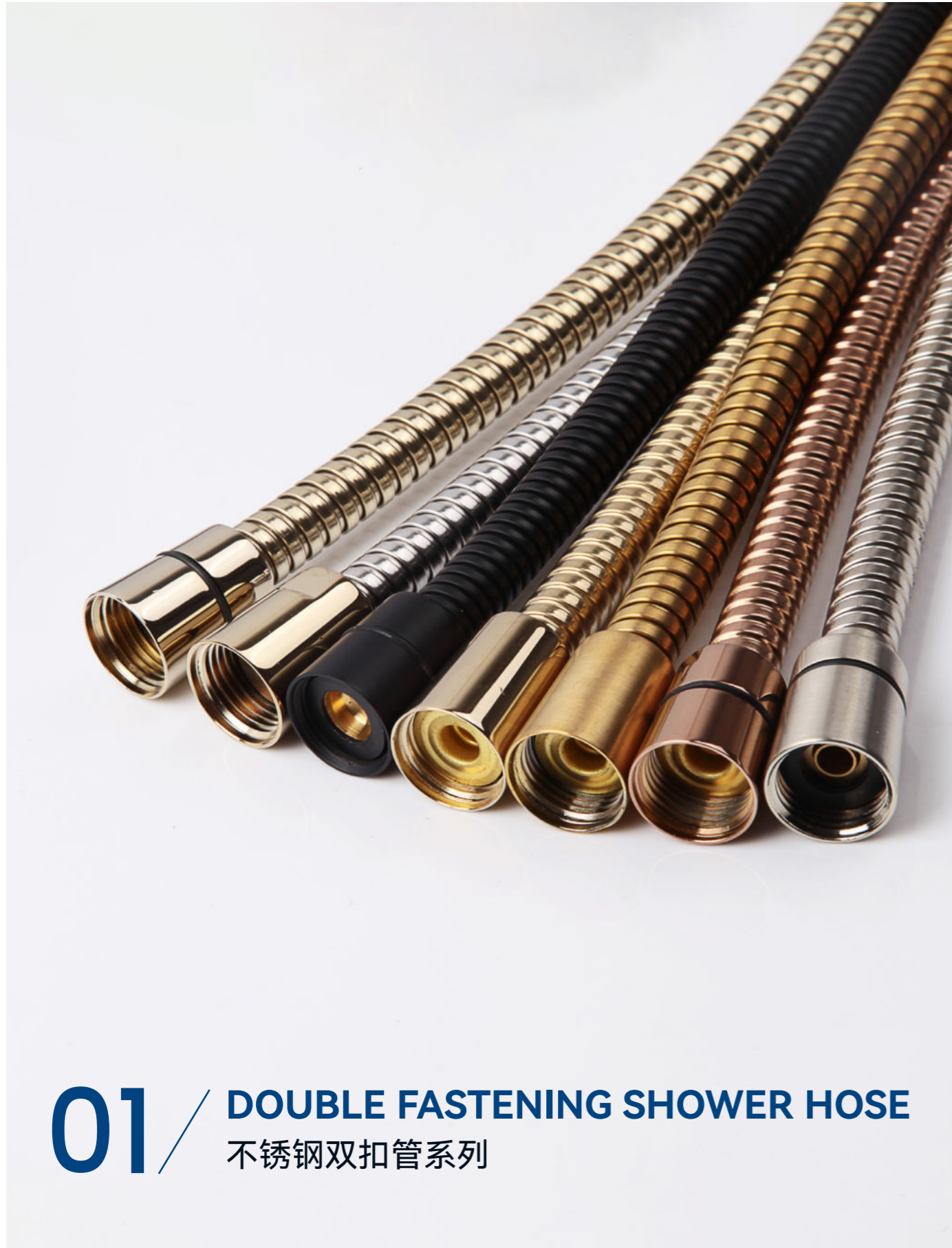

**01 / DOUBLE FASTENING SHOWER HOSE**  
**不锈钢双扣管系列**



360°防缠绕技术

**不锈钢淋浴系列**

- 不锈钢带 S.S: 201 301 304
- 铜带 Brass: H62 H65
- 内管材质 Inner hose: PVC/EPDM
- 表面处理 Finish: 电镀 Chrome 电解 Electrylse 仿古色 Archaise  
 红古色 Red bronze 青古色 Green bronze  
 钛金色 Gold 黑镍 Black nickel
- 温度 Temperature: 0° C- 90° C
- 工作压力 Working pressure: ≤ 0.7Mpa
- 规格 Outer Diameter: Ø10-16
- 尺寸 Size: 任何规格均可生产 All Specifications Can Be Produced

HS8102



HS8103



HS8107



HS8108



HS8104



HS8105



HS8109



HS8110



HS8101



HS8106







# 02 / PVC SHOWER HOSE

PVC花洒淋浴管

## 抗菌防霉 PVC 淋浴管

- 材质 Material: PVC+ 银粉 Silvery Powder (多种颜色)
- 温度 Temperature:  $\leq 65^{\circ}\text{C}$
- 拉力 Tensibility: 60-80kg
- 工作压力 Working Pressure:  $\leq 0.7$  (MPa)
- 尺寸 Size: 1.2M/1.5M/1.8 M/2M/2.5M/3M
- 颜色 colour: 银粉 Silver powder
- 大肠杆菌: 99.99%
- 金黄色葡萄球菌: 99.99%



360°防缠绕设计



HS8801



HS8802



HS8807



HS8808



HS8803



HS8804



HS8809



HS8810



HS8805



HS8806







# 03 / PULLING TUBE SERIES

## 抽拉管系列

CL9101



CL9104



CL9102



CL9103



### 不锈钢抽拉管系列

- 不锈钢带 S.S: 201 301 304
- 铜带 Brass: H62 H65
- 内管材质 Inner hose: PVC/EPDM
- 表面处理 Finish: 电镀 Chrome 黑镍 Black nickel
- 温度 Temperature: 0° C- 90° C
- 工作压力 Working pressure: ≤ 0.7mpa
- 规格 Outer Diameter: Ø10-14
- 尺寸 Size: 任何规格均可生产 All Specifications Can Be Produced

- 产品名称 Product name:  
360度尼龙抽拉管 360 degree nylon drawpipe
- 产品材质 Material:  
精制黄铜 Refined brass、PA6尼龙丝 PA6 nylon、PVC、PE、PEX
- 适用温度 Temperature: ≤90°C
- 产品特点 Product Features: 管身耐磨能承受长时间抽拉、具备万向和防缠绕功能, 内管材质符合NSF认证。 Refined brass, PA6 nylon wire, PVC, PE, and PEX pipes are wear-resistant and can withstand long-term pulling, have universal and anti winding functions, and the inner pipe material meets NSF certification.



# 04 / STAINLESS STEEL CONNECTING HOSE

## 不锈钢连接软管



环保

健康

安全

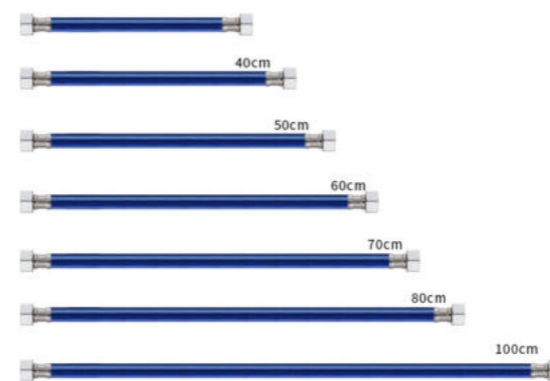

### 不锈钢连接软管

- 不锈钢丝 S.S: SUS 304
- 铜芯铜套 Brass Core.Brass Case: H59 / H58 / H57 / C69300 / DR
- 不锈钢 钢芯钢套 S.S Core.S.S Case: SUS 304
- 内管材质 Inner Hose: EPDM/TPE/PEX/TPU
- 温度 Temperature: 0° C-100° C
- 工作压力 Working pressure: 0-3.5Mpa
- 规格 Outer Diameter: Ø8-32
- 表面处理 Finished: 电镀 Chrome 洗镍 Nickel 原铜色 Brass
- 尺寸 Size: 任何规格均可生产 All Specifications Can Be Produced



LJ8502



LJ8503



LJ8504



LJ8505



LJ8506



LJ8508



LJ8509



LJ8510



05 / STAINLESS STEEL EXPLOSION-PROOF CONNECTING HOSE 不锈钢防爆连接软管

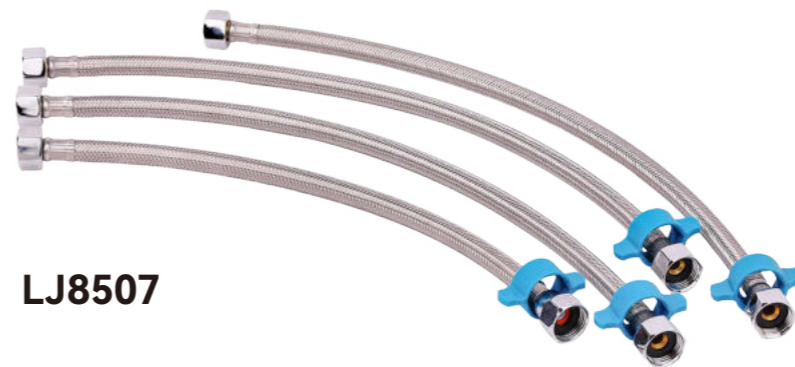

LJ8507

不锈钢防爆连接软管

- 内置防爆 Built-in explosion-proof
- 自动启动 Start automatically
- 瞬间止水 Instantaneous water stop
- 智能复位 Intelligent reset



# 06 / ANTISEPTIC FAUCET TUBE

## 抗菌龙头管



### 抗菌龙头管

- 不锈钢丝 S.S: SUS 304
- 铜芯铜套 Brass Core.Brass Case: H59 / H58 / H57 / C69300 / DR
- 不锈钢 钢芯钢套 S.S Core.S.S Case: SUS 304
- 内管材质 Inner Hose: EPDM/TPE/PEX/TPU
- 温度 Temperature: 0° C-100° C
- 工作压力 Working pressure: 0-3.5Mpa
- 规格 Outer Diameter: Ø8-32
- 表面处理 Finished: 电镀 Chrome 洗镍 Nickel 原铜色 Brass
- 尺寸 Size: 任何规格均可生产 All Specifications Can Be Produced



JS8302



JS8303



JS8304



JS8305



JS8306



JS8307



JS8301



# 07 / STAINLESS STEEL BELLOWS 不锈钢波纹管

BW8702



## 不锈钢波纹管

- 管体材质 Hose Material: SUS 304
- 螺母 Nut: 铜材 Brass、SUS304/H59/H57
- 温度 Temperature: 0° C-100° C
- 工作压力 Working pressure: ≤1 (MPa)
- 规格 Outer Diameter: F1/2\*1/2 F1/2\*M1/2 F3/4\*F3/4  
F3/4\*M3/4 F1\*F1 F1\*M1 F1-1/2\*M1-1/2
- 尺寸 Size: 任何规格均可生产 All Specifications Can Be Produced



# 08 / GAS CORRUGATED PIPE

## 燃气波纹管



### 燃气管

- 管体材质Hose Material: SUS 304
- 螺母Nut: 铜材Brass、SUS304/H59/H57
- 温度 Temperature: 0° C-100° C
- 工作压力 Working pressure: ≤1 (MPa)
- 规格 Outer Diameter: F1/2\*1/2 F1/2\*M1/2 F3/4\*F3/4  
F3/4\*M3/4 F1\*F1 F1\*M1 F1-1/2\*M1-1/2
- 尺寸 Size: 任何规格均可生产 All Specifications Can Be Produced

### 内外丝直通

• 1/2" X3/4"



### 冲压工具



### 燃气阀门

• 1/2"



### 外丝直通

• 1/2" X3/4"



### 燃气管割刀



### 燃气阀门

• 1/2" (3/4")



### 燃气内丝三通

• 1/2"



### 外丝直通

• 1/2"







# 09 / BOURDON TUBE

## 弹簧管

TH8601



TH8603



TH8602



### 弹簧管

- 产品名称 Product name:  
防爆弹簧线管 Explosion proof spring conduit
- 产品材质 Material:  
环保PU材料 Environmentally friendly PU materials、ABS、POM、尼龙纤维 nylon fibers
- 工作压力 Working pressure: 0-5kg
- 使用领域 Field of use:  
卫生间 Toilet、厨房 kitchen、浴室 bathroom
- 产品特点 Product Features:  
高压防爆 High pressure explosion-proof、防缠绕 anti winding  
节省空间 space saving、光洁易清洁 smooth and easy to clean
- 执行标准 Executive standards: GB/T23448-2009





# NOZZLE & VALVE

水嘴角阀

龙头类 / 浴室挂件 / 排杆 / 地漏 / 软管 / 水嘴角阀 / 安全扶手



### Z1T60007

- 洗衣机水嘴  
Washing machine nozzle
- 铜合金&Copper alloy



### Z1T60019

- 双功能洗衣机水嘴  
Washing machine nozzle
- 铜合金&Copper alloy



### Z1T60045

- 双功能角阀&valve
- 铜合金&Copper alloy



### Z1T60001

- 角阀&valve
- 铜合金&Copper alloy



### Z1T60002

- 角阀&valve
- 铜合金&Copper alloy



### Z1T60022

- 角阀&valve
- 铜合金&Copper alloy



### Z1T60020

- 洗衣机水嘴  
Washing machine nozzle
- 铜合金&Copper alloy



### Z1T60003

- 角阀&valve
- 铜合金&Copper alloy



### Z1T60004

- 角阀&valve
- 铜合金&Copper alloy



### Z1T60023

- 角阀&valve
- 铜合金&Copper alloy



### Z1T60024

- 角阀&valve
- 铜合金&Copper alloy

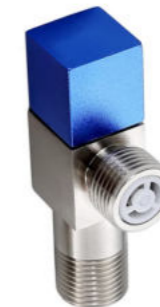

### Z1T60025

- 角阀&valve
- 铜合金&Copper alloy

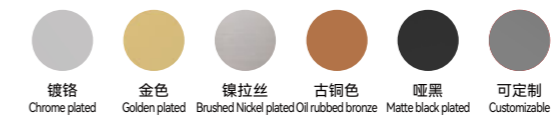
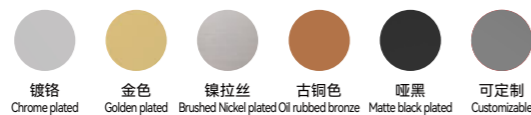

### Z1T60026

- 角阀&valve
- SUS304



### Z1T60027

- 角阀&valve
- SUS304



### Z1T60028

- 角阀&valve
- 铜合金&Copper alloy



### Z1T60044

- 角阀&valve
- 铜合金&Copper alloy



### Z1T60036

- 双功能角阀&valve
- 铜合金&Copper alloy



### Z1T60037

- 双功能角阀&valve
- 铜合金&Copper alloy



### Z1T60029

- 角阀&valve
- 铜合金&Copper alloy



### Z1T60030

- 角阀&valve
- 铜合金&Copper alloy



### Z1T60031

- 角阀&valve
- 铜合金&Copper alloy



### Z1T60038

- 双功能角阀&valve
- 铜合金&Copper alloy



### Z1T60042

- 双功能角阀&valve
- 铜合金&Copper alloy



### Z1T60043

- 双功能角阀&valve
- 铜合金&Copper alloy

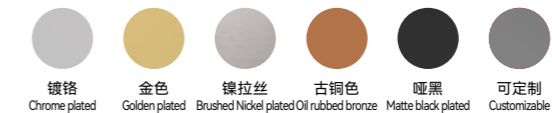
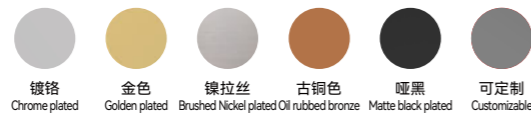



### Z1T60046

- 双功能角阀&valve
- 铜合金&Copper alloy



### Z1T60047

- 双功能角阀&valve
- 铜合金&Copper alloy

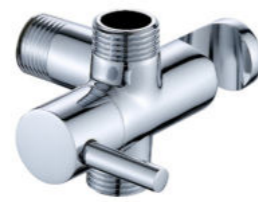

### Z1T60048

- 双功能角阀&valve
- 铜合金&Copper alloy



### Z1T60008

- 洗衣机水嘴  
Washing machine nozzle
- 铜合金&Copper alloy



### Z1T60009

- 洗衣机水嘴  
Washing machine nozzle
- 铜合金&Copper alloy



### Z1T60010

- 洗衣机水嘴  
Washing machine nozzle
- 铜合金&Copper alloy



### Z1T60049

- 双功能角阀&valve
- 铜合金&Copper alloy



### Z1T60032

- 双功能角阀&valve
- 铜合金&Copper alloy



### Z1T60006

- 洗衣机水嘴  
Washing machine nozzle
- 铜合金&Copper alloy



### Z1T60011

- 洗衣机水嘴  
Washing machine nozzle
- 铜合金&Copper alloy



### Z1T60021

- 洗衣机水嘴  
Washing machine nozzle
- 铜合金&Copper alloy



### Z1T60005

- 水嘴&Water nozzle
- 铜合金&Copper alloy

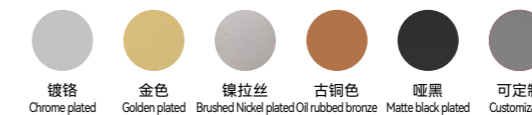
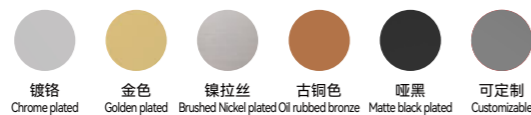

### Z1T60012

- 水嘴&Water nozzle
- 铜合金&Copper alloy



### Z1T60013

- 水嘴&Water nozzle
- 铜合金&Copper alloy



### Z1T60014

- 水嘴&Water nozzle
- 铜合金&Copper alloy



### Z1T60040

- 水嘴&Water nozzle
- 铜合金&Copper alloy



### Z1T60041

- 水嘴&Water nozzle
- 铜合金&Copper alloy



### Z1T60017

- 水嘴&Water nozzle
- 铜合金&Copper alloy



### Z1T60015

- 水嘴&Water nozzle
- 铜合金&Copper alloy



### Z1T60016

- 水嘴&Water nozzle
- 铜合金&Copper alloy



### Z1T60039

- 水嘴&Water nozzle
- 铜合金&Copper alloy



### Z1T60018

- 水嘴  
Water nozzle
- 铜合金  
Copper alloy



### Z1T60033

- 双功能水嘴  
Water nozzle
- 铜合金  
Copper alloy



### Z1T60034

- 双功能水嘴  
Water nozzle
- 铜合金  
Copper alloy



### Z1T60035

- 双功能水嘴  
Water nozzle
- 铜合金  
Copper alloy

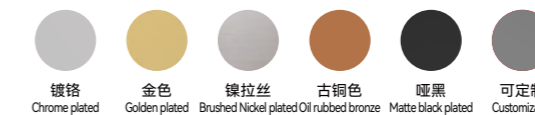
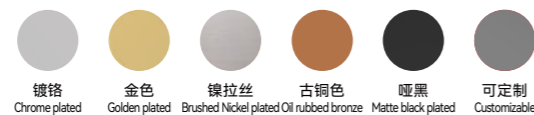



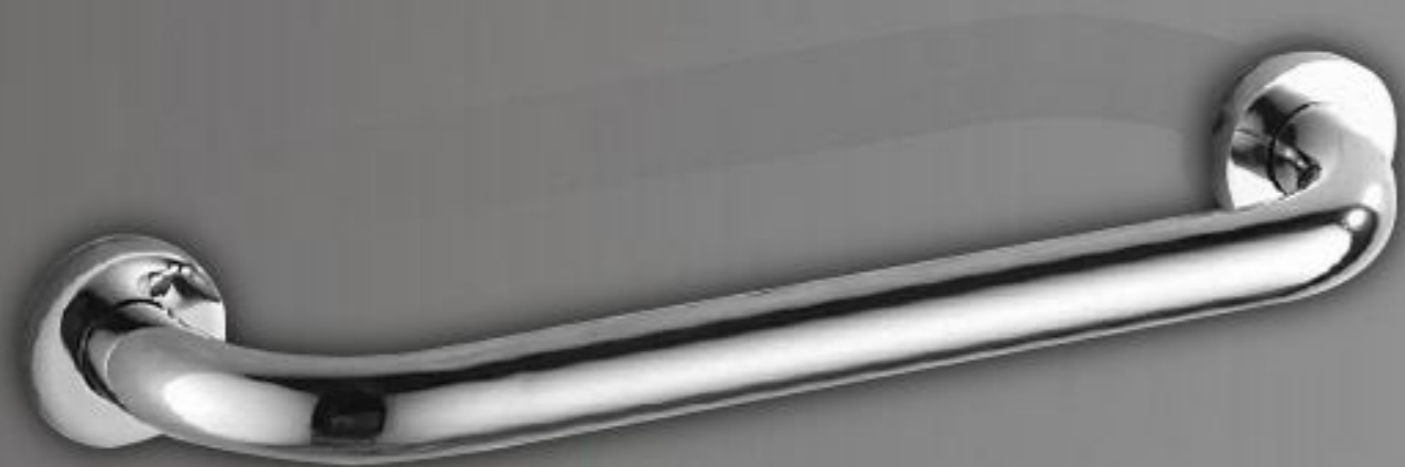

# BATHROOM HANDRAIL

安全扶手

龙头类 / 浴室挂件 / 排杆 / 地漏 / 软管 / 水嘴角阀 / 安全扶手

### Z1Y60003

- 浴室扶手&Bathroom handrail
- SUS304
- 25管16寸直扶手&25 pipe 16 inch straight handrail



### Z1Y60004

- 浴室扶手&Bathroom handrail
- SUS304
- 25管18寸直扶手&25 pipe 18 inch straight handrail



### Z1Y60009

- 浴室扶手&Bathroom handrail
- SUS304
- 32管16寸直扶手&32 pipe 16 inch straight handrail



### Z1Y60010

- 浴室扶手&Bathroom handrail
- SUS304
- 32管18寸直扶手&32 pipe 18 inch straight handrail



### Z1Y60005

- 浴室扶手&Bathroom handrail
- SUS304
- 25管20寸直扶手&25 pipe 20 inch straight handrail



### Z1Y60006

- 浴室扶手&Bathroom handrail
- SUS304
- 25管24寸直扶手&25 pipe 24 inch straight handrail



### Z1Y60011

- 浴室扶手&Bathroom handrail
- SUS304
- 32管18寸曲扶手&32 tube 18 inch curved handrail



### Z1Y60012

- 浴室扶手&Bathroom handrail
- SUS304
- 32管24寸直扶手&32 pipe 24 inch straight handrail



### Z1Y60007

- 浴室扶手&Bathroom handrail
- SUS304
- 25管18寸曲扶手&25 tube 18 inch curved handrail



### Z1Y60008

- 浴室扶手&Bathroom handrail
- SUS304
- 32管20寸直扶手&32 pipe 20 inch straight handrail

